

2023

EDITION 02

US Dollar Price Guide

**FRÖVI**<sup>®</sup>



<b>ZONING</b>	<b>18</b>
BAMBOO	26
COLONY	38
RETREAT	20



<b>COLLABORATION TABLES</b>	<b>44</b>
BLUME	54
FOUNDRY GIANT	118
* ISLE	46
JIG SOCIAL	104
RELIC	78
RELIC AT WORK	70
RELIC CLOUD	98
RELIC PROJECT TABLE	64
SLEND A	112



<b>SEATING   SOFT SEATING</b>	<b>122</b>
ALTO SOFA	158
* BAE	132
BLUME LOUNGE CHAIR	154
BOHO	138
DOWNTOWN	194
DRUM	212
ERA	190
FLO RD	162
HOME	172
HUDDLE MODULAR	206
ILK	178
JIG MODULAR	202
JIG SOFA	198
* SAIL SOFA	124
SCANDI	186
SCRUM SOFA	170
SNUG MODULAR	146
SNUG SOFA	150
TROST	142



<b>SEATING   CHAIRS &amp; STOOLS</b>	<b>214</b>
BLUME CHAIR & STOOL	220
EGO	246
GROW STOOL	252
ORA	228
RELIC BENCH & STOOL	242
SCANDI CHAIR & STOOL	234
SWING	224
TIPSY STOOL	232
VECK	238
WISH	216



<b>BOOTHS</b>	<b>254</b>
HOME	270
HUDDLE CAVE	284
HUDDLE WORK BOOTH	280
JIG CAVE	274
* SAIL BOOTH	256
RETREAT	264



<b>TABLES</b>	<b>290</b>
FLO RD TABLE	320
FONT TABLE	292
FOUNDRY GIANT	328
LAPTOP TABLE	350
MARGIN TABLE	332
MONO GIANT TABLE	340
MONO TABLE	336
ORBIT TABLE	304
OSTI	316
OSTI CLOUD	312
* PEGGY TABLE	296
PEEL TABLE	300
SLEND A TABLE	322
WIRE COFFEE TABLE	346
WRAPT COFFEE TABLE	308
YAK COFFEE TABLE	342



<b>OUTDOOR</b>	<b>352</b>
OSTI	358
OSTI CLOUD	354
VECK	362



<b>ACCESSORIES</b>	<b>366</b>
CUSHIONS	372
HOME MOBILE MEDIA WALL	368

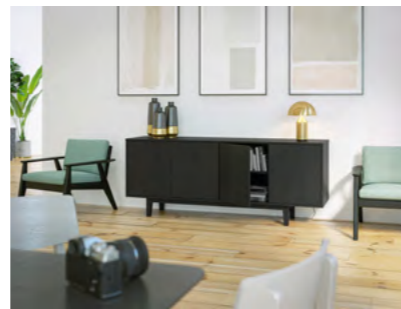

<b>SHELVING &amp; STORAGE</b>	<b>374</b>
BAMBOO	376
FOUNDRY	396
JIG CREDENZA	392
RELIC CREDENZA	388



<b>POWER</b>	<b>400</b>
DISCREET POWER	402
DUET POWER	403



<b>INFORMATION</b>	<b>404</b>
FABRIC BANDS	406
FREIGHT PROGRAM - USA	416
FREIGHT PROGRAM - CANADA	418
OTHER INFORMATION	420

**INTERACTIVE FEATURES**

To make our digital Price guide more user friendly, we have added a series of interactive links, QR codes and page links throughout.

Look out for the icons below or click on the range name on the contents to jump to page.

← JUMP TO CONTENTS



\* New product



2023



est. 1976



1985



2015



1995



# A British brand est. 1976

We are a family owned British furniture company with a name inspired by Scandinavian design.

With Frövi, you'll always find innovative, distinctive furniture with signature designs, created through the best of British craftsmanship since 1976.

Every care is taken to ensure that all our products are manufactured to a very high standard, so you can be sure that when purchasing a piece of Frövi furniture you are purchasing a quality product.

Our showroom is in the heart of design in North America, situated within the prestigious Merchandise Mart, Chicago.

Frövi furniture is designed for commercial environments, and you can be confident that every piece will deliver on quality, strength and value, all supported by our 10-year warranty.

Whether you are an architect, designer, specifier or furniture dealership, we are confident that we can deliver the right products and services to complement your project.



2020

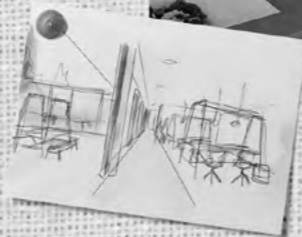

2017



2022



2022



2016



2019



2019

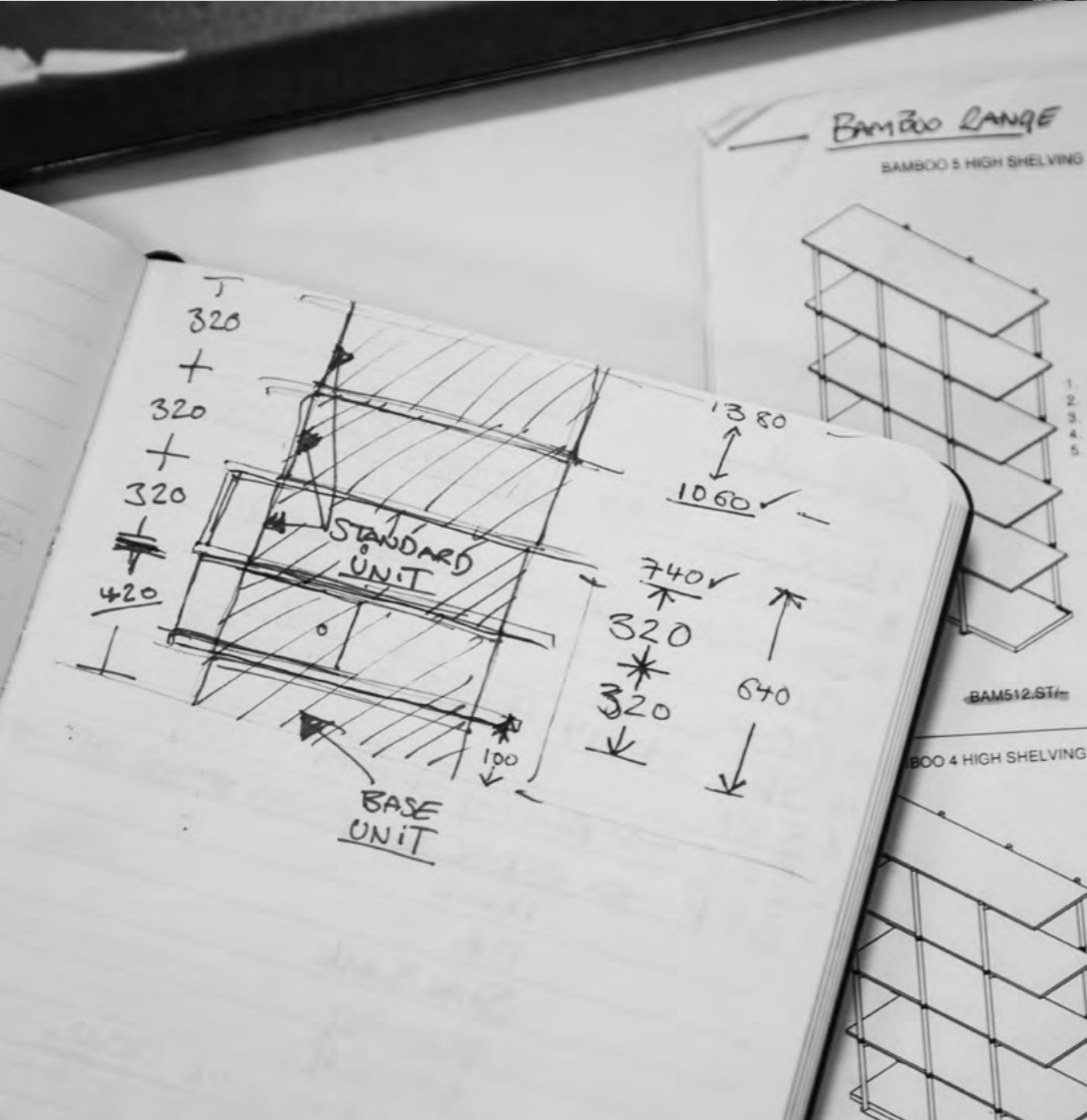

## Behind the scenes

At Frövi we pride ourselves on creating forward thinking innovative products. That is why we have our own in-house designers that consistently exceed convention and deliver new concepts that create ripples throughout the industry. Based in Oxfordshire, UK, our designers produce increasingly impressive concepts, with a keen attention to detail and the use of innovative new materials. Our recently opened logistics center in Texas, helps us support our North American customers even further.

Each design reflects the creative philosophy of our designers, with a passionate transition from thought to concept using traditional drawing methods and 3D computer aided design. The initial design is then quickly followed by prototyping and development, then the first commercially available designs make their way to our showroom.

The design process however, never truly ends as the team constantly question how our existing designs can be improved – as you will see throughout this price guide.

There is something for every project within our new collection, designed to suit differing workspace requirements, installation timeframes and budgets.

Explore the endless design possibilities.

# Design for today

---

As a furniture designer, we understand our operations have a far-reaching impact on the environment. This is something as individuals and as a business we take seriously.

We also know that with effort and hard work we can make a positive improvement on the life cycle of our furniture products, reducing waste and pollution through more sustainable material selection and more efficient manufacturing processes.

Frövi is committed to providing sustainable, environmentally responsible products, including manufacturing and material transparency.

## Frövi Environmental Accreditations & Processes



### ISO ACCREDITATION

Frövi is a registered ISO 9001:2015 and ISO 14001:2015 company. These quality assurance and environmental management accreditations give customers and clients the peace of mind in all Frövi products.



### FISP

We are registered with the FISP regulatory body, which is an independently certified sustainability programme specifically designed for the Furniture Industry supply chain. FISP identifies best practise to drive continual improvement of member's social and environmental impacts, securing sustainable financial success.



### SCS INDOOR ADVANTAGE GOLD

Frövi is proud to announce that SCS Global Services has issued its Indoor Advantage™ Gold certification for indoor air quality across our entire collection of products. The products have been tested for low Volatile Organic Compound (VOC) emissions in various categories including open plan and private office workstations, seating and school classroom parameters.



## Unique materials & finishes

---

At Frövi, our innovative finishes set us apart.

Our focus for sustainable and responsible material sourcing, has resulted in seating made from sustainable cork, tabletops made from recycled fridge freezer plastic, shelving made from recycled steel rebar and our forward-thinking Bamboo range.

Whether you are looking for a statement piece, or furniture that seamlessly blends into your workspace, with an almost endless catalog of fabric choices and color finishes, your chosen Frövi furniture will perfectly complement its environment.



# Quick Ship

Our Quick Ship program is expanding with a number of our most popular products now available. This strengthens our ambitions to support our customers by manufacturing in North America, creating significantly reduced lead times, especially for projects requiring quick turnarounds whilst minimizing our impact on the environment.

Look out for the Quick Ship icon for applicable products.

More products coming soon.



Products	Terms of Quick Ship
Wish Chair	Natural oak and black stained ash wood veneer finishes available.
Relic Cloud	141.7" x 63" with power. Black or raw steel frames with rustic oak or rustic black oak laminate tops.
Margin Table	High or low – 23.6" diameter, with black frame and marble laminate top.
Bamboo	Available in a black RAL frame except the planter, mobile table, and freestanding cupboards.
Ilk	Both single and two seater options with the 4-leg wooden base, and tilt base options.
Boho Chair	All options available.

SOFT SEATING, CHAIRS AND STOOLS



**Boho Chair**  
width 34, depth 30, height 33.5, seat height 18"

FABRIC	ORDER CODE	PRICE
1	BHO.FBB	\$3,039
2	BHO.FBC	\$3,274
3	BHO.FBD	\$3,460
4	BHO.FBE	\$3,648
5	BHO.FBF	\$3,930
6	BHO.FBG	\$4,492
7	BHO.FBH	\$5,054
8	BHO.FBI	\$5,617



**Ilk Tilt**  
width 31, depth 31.5, height 44, seat height 17"

FABRIC	ORDER CODE	PRICE
Black Frame		
1	ILF1SH.4ST.FBB	\$2,376
2	ILF1SH.4ST.FBC	\$2,668
3	ILF1SH.4ST.FBD	\$2,973
4	ILF1SH.4ST.FBE	\$3,293
5	ILF1SH.4ST.FBF	\$3,628
6	ILF1SH.4ST.FBG	\$3,981
7	ILF1SH.4ST.FBH	\$4,335
8	ILF1SH.4ST.FBI	\$4,688

Leather pricing available upon application.



**Ilk High 4 Leg**  
width 31, depth 31.5, height 44, seat height 17"

FABRIC	ORDER CODE	PRICE
1	ILF1SH.4W1.FBB	\$2,716
2	ILF1SH.4W1.FBC	\$3,008
3	ILF1SH.4W1.FBD	\$3,314
4	ILF1SH.4W1.FBE	\$3,633
5	ILF1SH.4W1.FBF	\$3,968
6	ILF1SH.4W1.FBG	\$4,322
7	ILF1SH.4W1.FBH	\$4,675
8	ILF1SH.4W1.FBI	\$5,028

Leather pricing available upon application.



**Ilk Low 4 Leg**  
width 31, depth 31, height 32.5, seat height 17"

FABRIC	ORDER CODE	PRICE
1	ILF1SL.4W1.FBB	\$2,101
2	ILF1SL.4W1.FBC	\$2,375
3	ILF1SL.4W1.FBD	\$2,620
4	ILF1SL.4W1.FBE	\$2,875
5	ILF1SL.4W1.FBF	\$3,142
6	ILF1SL.4W1.FBG	\$3,424
7	ILF1SL.4W1.FBH	\$3,706
8	ILF1SL.4W1.FBI	\$3,988

Leather pricing available upon application.



**Ilk Two Seater Low 4 Leg**  
width 56.5, depth 32, height 32.5, seat height 17"

FABRIC	ORDER CODE	PRICE
1	ILF.2SL.4W1.FBB	\$6,989
2	ILF.2SL.4W1.FBC	\$7,225
3	ILF.2SL.4W1.FBD	\$7,465
4	ILF.2SL.4W1.FBE	\$7,821
5	ILF.2SL.4W1.FBF	\$8,175
6	ILF.2SL.4W1.FBG	\$8,885
7	ILF.2SL.4W1.FBH	\$9,594
8	ILF.2SL.4W1.FBI	\$10,302
LEATHER		PRICE
L1	ILF.2SL.4W1.FBL1	\$10,302
L2	ILF.2SL.4W1.FBL2	\$11,621
L3	ILF.2SL.4W1.FBL3	\$12,503



**Ilk Two Seater High 4 Leg**  
width 56.5, depth 32, height 44, seat height 17"

FABRIC	ORDER CODE	PRICE
1	ILF.2SH.4W1.FBB	\$7,620
2	ILF.2SH.4W1.FBC	\$7,878
3	ILF.2SH.4W1.FBD	\$8,138
4	ILF.2SH.4W1.FBE	\$8,526
5	ILF.2SH.4W1.FBF	\$8,911
6	ILF.2SH.4W1.FBG	\$9,686
7	ILF.2SH.4W1.FBH	\$10,464
8	ILF.2SH.4W1.FBI	\$11,237
LEATHER		PRICE
L1	ILF.2SH.4W1.FBL1	\$11,237
L2	ILF.2SH.4W1.FBL2	\$12,278
L3	ILF.2SH.4W1.FBL3	\$13,180





**Wish Chair**  
width 22, depth 22.5, height 30, seat height 17.5"

SEAT FINISH	ORDER CODE	PRICE
Wood Veneer		
Natural Oak	WSC.BK.ST/NOK	\$1,286
Black Stained Ash	WSC.BK.ST/BA	\$1,286

**COLLABORATION AND COFFEE TABLES**



**Relic Cloud with Power**  
height 79, table top height 29.5"

SIZE (IN)	TOP PIECES	CUT-OUTS	ORDER CODE	PRICE
				<b>Rustic</b>
				<b>Black/Raw</b>
141.5 x 63	4	2	RSO.360.160.WPV	\$24,770



**Margin Table High**  
height 17.5, top thickness 1"

TOP TYPE	SIZE (IN)	ORDER CODE	PRICE
			Black
Rustic Marble Effect	23.5 dia	MTH.60D.45	\$1,888



**Margin Table Low**  
height 14, top thickness 1"

TOP TYPE	SIZE (IN)	ORDER CODE	PRICE
			Black
Rustic Marble Effect	23.5 dia	MTH.60D.35	\$1,820

**BAMBOO**



**Bamboo 5 High - 1200**  
width 47, depth 17.5, height 74"

DESCRIPTION	ORDER CODE	PRICE
47"	BAM.512.ST	\$4,723



**Bamboo 5 High - 1800**  
width 71, depth 17.5, height 74"

DESCRIPTION	ORDER CODE	PRICE
71"	BAM.518.ST	\$7,360



**Bamboo 5 High Corner (Overlapping)**  
width 47, depth 47, height 74"

DESCRIPTION	ORDER CODE	PRICE
Corner	BAM.512.L/	\$7,577



**Bamboo Felt Panel**  
width 14, depth 0.5, height 31.5"

DESCRIPTION	ORDER CODE	PRICE
Felt Panel	BAM-FP	\$232

# Zoning

BAMBOO  
COLONY  
RETREAT

26  
38  
20



# RETREAT

---

Retreat has been designed to embrace the new way of working and office design. It is a modular piece of 'micro architecture' which sits as a hybrid between the traditional glass box meeting pods and an upholstered booth sofa, with a focus and consideration towards human interaction.



## FEATURES

---

- Use of sustainable materials such as Bamboo and PET Felt
- Developed for informal team meetings and spontaneous catch ups and the new way of digitally communicating
- Quick assembly
- Integrated power for charging
- Mobility kit included
- Adjustable feet
- Acoustic enhancement



Lighting not available in North America.

STEPS TO SPECIFY

Follow our guide and customize our products to suit your space

- 1 2 3 4 5

Select Configuration: Piece together different modules and add accessories  
Example configurations shown below

Outer panel finish Metal pergola finish

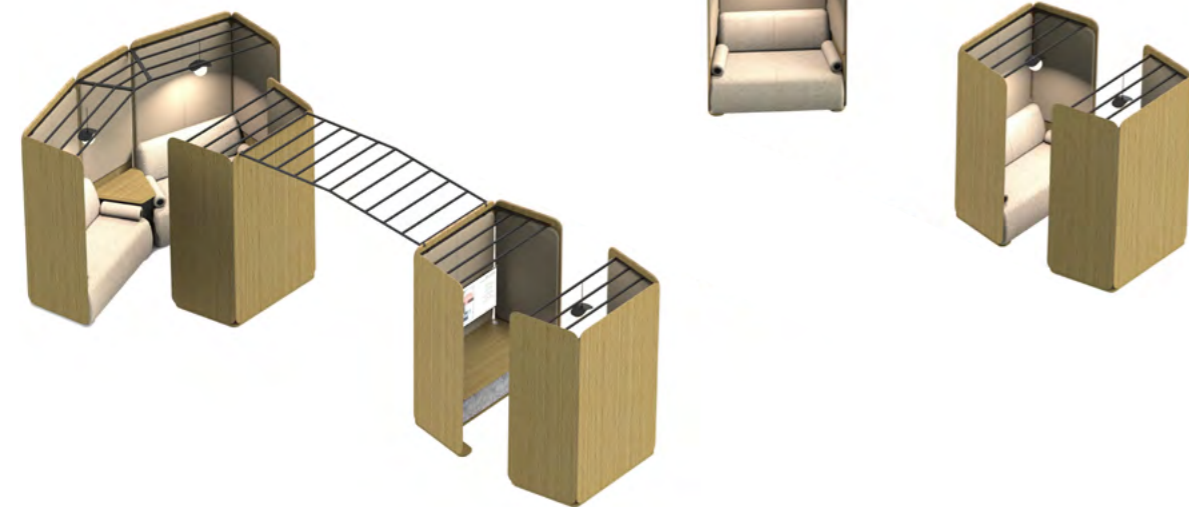

- 1 2 3 4 5

Select Inner Panel Finish: Available in fabric grades 1-8

- 1 2 3 4 5

Select Sofa Fabric: (sofa modules only) Available in fabric grades 1-8

Fabrics  
See pages 406-415

- 1 2 3 4 5

Select Felt Finish: (media centers only) Camel Fleck or Dark Gray

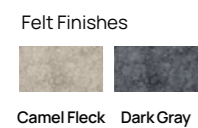

- 1 2 3 4 5

Select Accessories:

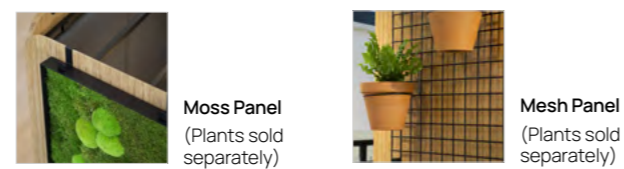

Supplied as standard per Retreat module, including integrated power:



**Power Cushion**  
Modules available in Black.  
Fabric will match the sofa.

Retreat - Two Seater includes:

- 1x Pair of Power Cushions that include 1x Twin USB Charge (1x Type-C & 1x Type-A).

Retreat Cove - Four Seater includes:

- 2x Pair of Power Cushions that include 1x Twin USB Charge (1x Type-C & 1x Type-A).

Retreat - Media Center includes:

- 1x Power Unit
- 1x Monitor Mount
- 1x Camera Mount

Note: Lighting is unavailable in North America. All power will be supplied with North American variant.  
Monitor, webcam and computer are not supplied by Frövi. Recommended screen size is 42 inches.

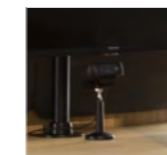

**Monitor and Camera Mount**  
Available in Black  
Media Center only



**Power Unit**  
1x Power Outlet  
Available in Black  
Media Center only  
Please note: NA power will be supplied



Lighting NOT available in North America. Metal pergola is supplied as standard for you to specify your own lighting solution.





**Retreat Two Seater**  
width 58, depth 30, height 83"

Fabric Band	ORDER CODE	PRICE
1	RTS.FBB	\$20,741
2	RTS.FBC	\$20,976
3	RTS.FBD	\$21,164
4	RTS.FBE	\$21,353
5	RTS.FBF	\$21,636
6	RTS.FBG	\$22,202
7	RTS.FBH	\$22,768
8	RTS.FBI	\$23,334



**Retreat Cove - Four Seater**  
width 121, depth 44.5, height 83"

Fabric Band	ORDER CODE	PRICE
1	RTCO.FBB	\$39,169
2	RTCO.FBC	\$39,629
3	RTCO.FBD	\$39,997
4	RTCO.FBE	\$40,365
5	RTCO.FBF	\$40,919
6	RTCO.FBG	\$42,023
7	RTCO.FBH	\$43,130
8	RTCO.FBI	\$44,234



**Retreat Media Center**  
width 58, depth 30, height 83"

Fabric Band	ORDER CODE	PRICE
2	RTMC	\$18,274

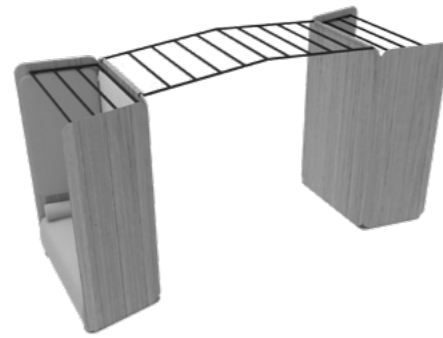

**Retreat Pergola Bridge** Sofa modules sold separately  
width 39.5, depth 96, height 4.5"

DESCRIPTION	ORDER CODE	PRICE
Pergola Bridge	RTPB	\$1,976



**Retreat Moss Panel** Plants and sofa modules sold separately  
width 19.5, depth 2, height 77"

DESCRIPTION	ORDER CODE	PRICE
Moss Panel	RTMP	\$764



**Retreat Mesh Panel** Plants and sofa modules sold separately  
width 20.5, depth 1.5, height 77"

DESCRIPTION	ORDER CODE	PRICE
Mesh Panel	RTMSP	\$764



# bamboo®

We've taken our responsibility for sustainable design and production one step further. Crafted from recycled ocean plastic, recycled PET Felt, and pressed bamboo our Bamboo range has been designed with our planet in mind. Available in straight and curved shelving options means style meets sustainability. Our curved shelving option is a response to the emerging popularity of a more organic and fluid style of landscape within the workplace and can be used to create spaces alongside curved curtain walls and soft lounge-style seating. Create your own design using our online Bamboo configuration tool.



## FEATURES

Bamboo is a carbon negative material and the use of bamboo products can help achieve a higher certification level for LEED and BREEAM

Configurable for any workspace

Easy and quick to assemble, supplied with tools for quick install

100% recycled ocean plastic connectors

Framework available in any of our RAL colors

All shelves, cupboards & lockers made from side-pressed bamboo

Incorporate biophilia with integrated and mobile planters

Felt panel for pinboard use, made from a blend of 70% recycled and 30% virgin PET

Packaging is made from 100% recyclable cardboard, made from 80% recycled material

Height adjustable feet

Mobile table for agile working

Award-winning - Best of NeoCon Gold Award 2022

Quick Ship available on selected variations and finishes, see pages 12 - 17 for more information.



Scan to watch videos and find out more

 CONFIGURE





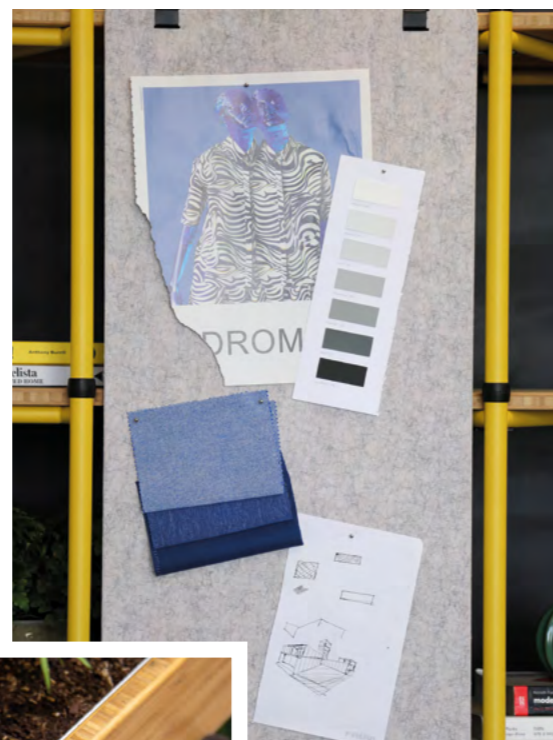

Felt Panel



Recycled ocean plastic connectors



Integrated and mobile planters



Storage Locker

Open Acrylic Back Unit



CONFIGURE YOUR OWN DESIGN ONLINE

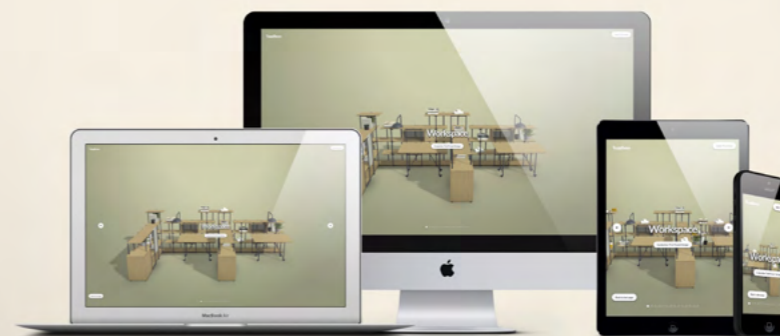

Use our online configurator at [frovidesign.com/bamboo](https://frovidesign.com/bamboo) to help you customise our presets or specify your own custom Bamboo configuration.

 CONFIGURE





# bamboo | environmentally conscious

Our Bamboo range has been created by our environmentally conscious in-house design team, where possible we have opted to use the most eco-friendly and low impact materials. This year, we've taken further steps towards a more sustainable future. It starts with the launch of our Bamboo collection, a range that uses environmentally conscious materials and processes. All our shelves, cupboards, storage boxes and tabletops in the range are made from bamboo. This material is widely known for being extremely sustainable hard wood alternative - it has a negative carbon footprint!



**bamboo uses 1/3 of the water consumption to grow than oak**

## sustainable buildings

The use of bamboo products can help achieve a higher certification level for LEED and BREEAM. It can also help achieve more points towards the building becoming WELL-aligned.



## one of the fastest growing plants

It only takes a year to grow back after it's been harvested. Some species grow more than 3 feet (1 meter) each day.



**bamboo uses no pesticides or chemical fertilisers**

## clean air

Bamboo releases 30% more oxygen than hardwoods and it absorbs 5 times more carbon dioxide than standard trees.



## low energy powder coating

Our specially designed powder coatings are cured at lower oven temperatures, which reduces energy usage and waste generation, lowering our overall carbon footprint.



## anti-bacterial

Bamboo has the ability to withstand and kill bacteria. It is also very easy to clean.

BASIC CONFIGURATION EXAMPLES

Visit [frovidesign.com/bamboo](http://frovidesign.com/bamboo) to configure your own



**Bamboo 5 High - 47.2"**  
width 47, depth 17.5, height 74"

DESCRIPTION	ORDER CODE	PRICE
47"	BAM.512.ST	\$4,723



**Bamboo 5 High - 70.8"**  
width 71, depth 17.5, height 74"

DESCRIPTION	ORDER CODE	PRICE
71"	BAM.518.ST	\$7,360



**Bamboo 2 High Planter**  
width 47, depth 17.5, height 37"

DESCRIPTION	ORDER CODE	PRICE
Planter	BAM-P512.ST	\$7,456

includes 2 trays & 8 planters



**Bamboo 2 High Planter on Castors**  
width 47, depth 17.5, height 37"

DESCRIPTION	ORDER CODE	PRICE
Planter on Castors	BAM-MP512.ST	\$7,967

includes 2 trays & 8 planters



**Bamboo 5 High Double Cupboard**  
width 47, depth 18.5, height 74"

DESCRIPTION	ORDER CODE	PRICE
Double Cupboard	BAM.512.CB2/	\$6,103



**Bamboo 5 High Corner (Overlapping)**  
width 47, depth 47, height 74"

DESCRIPTION	ORDER CODE	PRICE
Corner	BAM.512.L/	\$7,577



**Bamboo Mobile Table**  
width 47, depth 31.5, height 29"

DESCRIPTION	ORDER CODE	PRICE
Table	BAM-MT.AN.128R.NBA	\$1,582



**Bamboo Planter**  
width 23.5-47, depth 14.5, height 6"

DESCRIPTION	ORDER CODE	PRICE
23.5" - includes 1 tray & 2 planters	BAM-P.SBP	\$1,981
47" - includes 1 tray & 4 planters	BAM-P.DBP	\$3,027



**Bamboo Freestanding Single Cupboard**  
width 23.5, depth 18.5, height 30"

DESCRIPTION	ORDER CODE	PRICE
Freestanding Single Cupboard	BAM-CB.SFCS/	\$1,892



**Bamboo Freestanding Double Cupboard**  
width 47, depth 18.5, height 30"

DESCRIPTION	ORDER CODE	PRICE
Freestanding Double Cupboard	BAM-CB.SFCD/	\$3,768



**Bamboo Felt Panel**  
width 14, depth 0.5, height 31.5"

DESCRIPTION	ORDER CODE	PRICE
Felt Panel	BAM-FP	\$232



Selected Bamboo products in selected colors are available on Quick Ship, see pages 12 - 17 for more information.

BASIC CONFIGURATION EXAMPLES

Visit [frovidesign.com/bamboo](http://frovidesign.com/bamboo) to configure your own



**Curved Bamboo 2 High - 90 Degree**  
width 45.5, depth 21, height 29"

DESCRIPTION	ORDER CODE	PRICE
2 High	BAM.2.45R.90DEG.CU	\$2,821



**Curved Bamboo 3 High - 90 Degree**  
width 45.5, depth 21, height 43.5"

DESCRIPTION	ORDER CODE	PRICE
3 High	BAM.3.45R.90DEG.CU	\$3,711



**Curved Bamboo 4 High - 90 Degree**  
width 45.5, depth 21, height 58"

DESCRIPTION	ORDER CODE	PRICE
4 High	BAM.4.45R.90DEG.CU	\$4,602



**Curved Bamboo 5 High - 90 Degree**  
width 45.5, depth 21, height 73"

DESCRIPTION	ORDER CODE	PRICE
5 High	BAM.5.45R.90DEG.CU	\$5,492



**Curved Bamboo 2 High - 36 Degree**  
width 52.5, depth 19, height 29"

DESCRIPTION	ORDER CODE	PRICE
2 High	BAM.2.180R.36DEG.CU	\$2,821



**Curved Bamboo 3 High - 36 Degree**  
width 52.5, depth 19, height 29"

DESCRIPTION	ORDER CODE	PRICE
3 High	BAM.3.180R.36DEG.CU	\$3,711



**Curved Bamboo 4 High - 36 Degree**  
width 52.5, depth 19, height 29"

DESCRIPTION	ORDER CODE	PRICE
4 High	BAM.4.180R.36DEG.CU	\$4,602



**Curved Bamboo 5 High - 36 Degree**  
width 52.5, depth 19, height 29"

DESCRIPTION	ORDER CODE	PRICE
5 High	BAM.5.180R.36DEG.CU	\$5,492



**Cupboard and Curve Configuration** Double Cupboard and 5 High - 90 Degree  
width 81.5" depth 34.5" height 72"

DESCRIPTION	ORDER CODE	PRICE
Double Cupboard		\$11,595



**'S' Shape Configuration** 3 High - 36 Degree and 5 High - 36 Degree  
width 92" depth 47.5" height 72"

DESCRIPTION	ORDER CODE	PRICE
3 & 5 High		\$9,203



**Large Curve Configuration** 2 x 3 High - 36 Degree High  
width 81.5" depth 65" height 43.5"

DESCRIPTION	ORDER CODE	PRICE
2 x 3 High		\$7,422

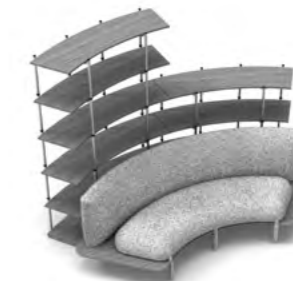

**Bamboo and Bae Configuration** 5 High - 36 Degree, 3 High - 36 Degree and 90 Degree Inwards  
width 92" depth 65" height 43.5"

DESCRIPTION	ORDER CODE	PRICE
5 & 3 High		\$18,469

# COLONY

Colony is all about reducing the built environment, creating visible boundaries and warm inviting spaces through the use of lighting, fabric and textures. The versatility of the interior space allows you to create a multitude of environments.

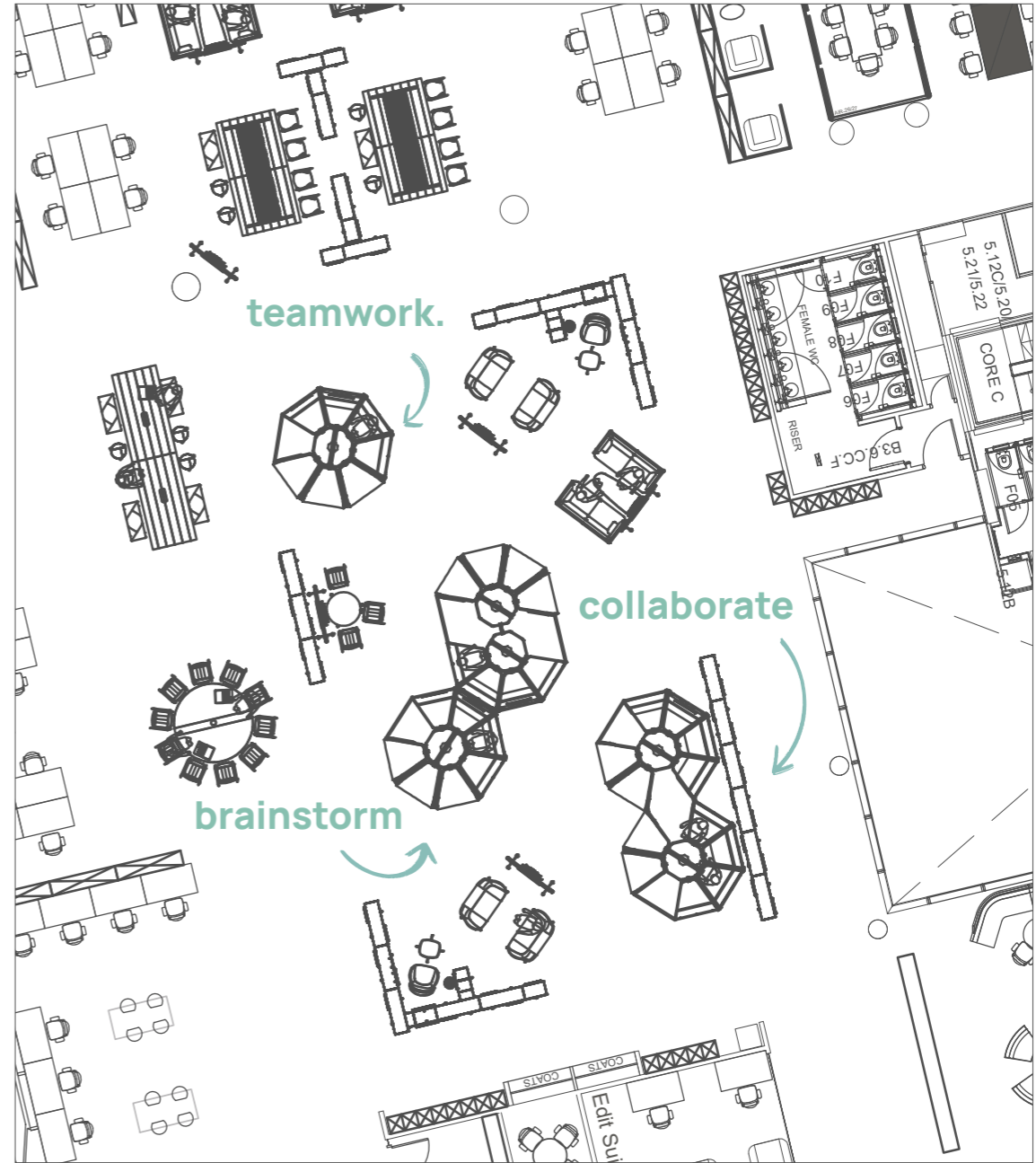

Use our online configurator at [frovidesign.com](https://frovidesign.com) to help you specify your own Colony and create custom designs.

 CONFIGURE





Layer fabric panels over felt or metal leaf panels

Lighting mount supplied as standard for you to specify your own solution

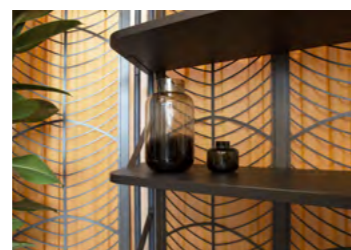
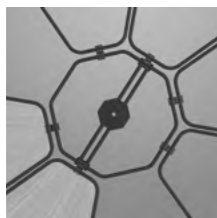

A range of accessories to configure your space



### CONFIGURE YOUR OWN DESIGN ONLINE



Use our online configurator at [frovidesign.com](http://frovidesign.com) to help you specify your own Colony and create custom designs.

 CONFIGURE

# Collaboration Tables

BLUME	54
FOUNDRY GIANT	118
* ISLE	46
JIG SOCIAL	104
RELIC	78
RELIC AT WORK	70
RELIC CLOUD	98
RELIC PROJECT TABLE	64
SLENDA	112

\* New product



# ISLE

\* NEW \*

Isle was developed as a response to the need for a softer more domestic feel to modern-day commercial furniture and designed as a true expression of simplicity in form. Using a minimalistic approach to materials and design we have created a statement table system that has an honest, playful character with concealed functionality for everyday use. A single natural material is used throughout Isle's silhouette bringing a softness to the surrounding space. Rounded ends promote inclusivity and social interaction, and the texture from the timber can help create a calm and tranquil atmosphere. Isle approaches function in a way that is true to itself with aesthetic benefits like cable management and below-surface power seamlessly hidden away from plain sight.



## FEATURES

- Softer more domestic feel to modern-day commercial furniture
- Minimalistic approach to materials and design
- Waterfall edge detail
- Rounded ends promote inclusivity
- High level of craftsmanship and finish
- Premium materials
- Seamless power flap
- Concealed cable management with cutout for cables
- Repairable solid ash tops increasing longevity





STEPS TO SPECIFY

Follow our guide and customize our products to suit your space

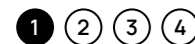

Select Size:  
Example sizes with chair configurations below,  
see page 42 for full range of sizes.

Diagrams show a 19.6" chair placed around the tables as seating capacity  
indication only. Capacity can be increased with the use of benches.  
Tables over 110" are more than one-piece tops, seams as shown below.

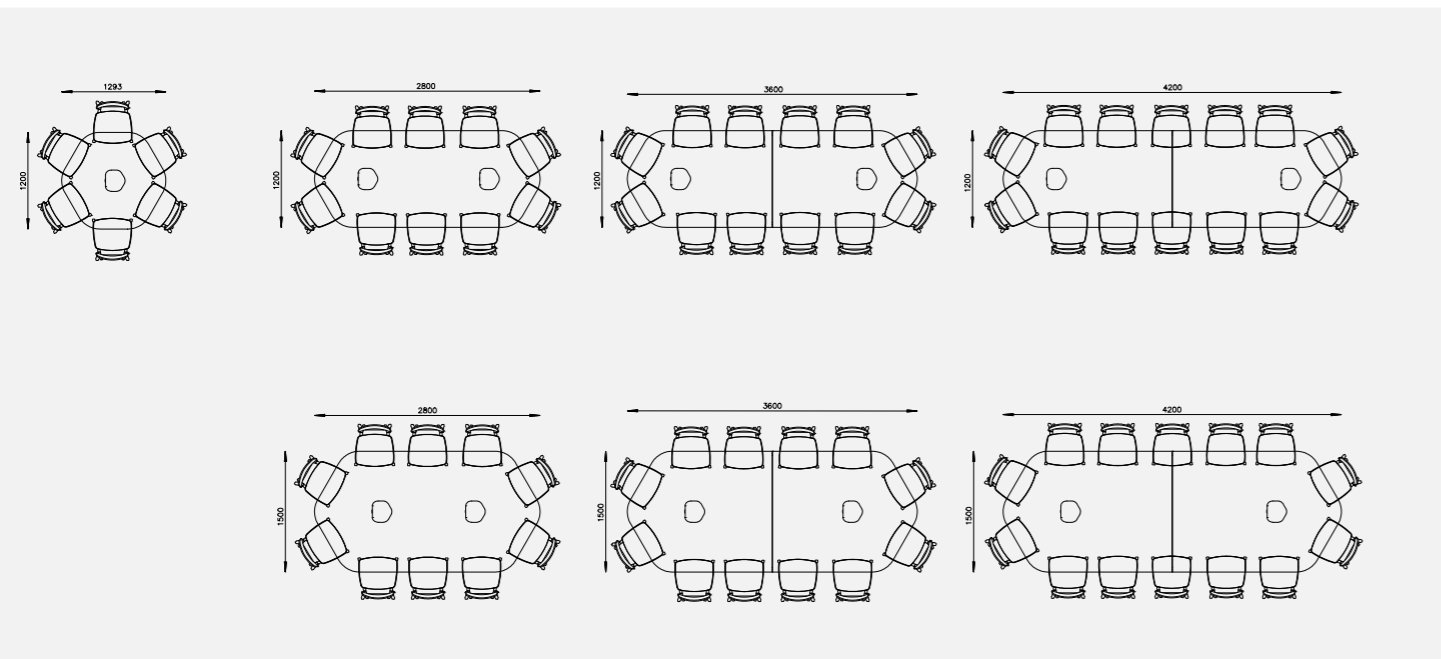

Select Power: Powered or Non-powered

Isle tables can be specified with or without integrated power.  
The Solid ash Isle tables with Power are supplied with a lift-out power flap. Cutline edge and Sawn edge tops are supplied with  
surface mounted power units. Power unit is 128mm diameter.

Power tray and  
module finish



Black

Standard power configuration for Isle Tables with Power

For power variations, the amount of power cut-outs per table varies depending on the length.  
Power modules per power cut-out are available with one of the options below. Please note, North American power will be supplied.

Table Length	Power Cut-outs
47 x 47	1
110 x 47	2
110 x 59	2
92.5 x 47	2 (Surface Power only)
141.5 x 47	2
141.5 x 59	2
165.5 x 47	2
165.5 x 59	2

Solid Ash table power:

Includes: 2 X 65w NA Power & 1x Twin USB Charge  
(1x Type-A & 1x Type-C). Available in Black. Includes  
cable management.



Cutline and Sawn Edge table power:

Includes: 2 X 65w NA Power & 1x Twin USB Charge  
(1x Type-A & 1x Type-C). Available in Black. Includes  
cable management.



Select Base Finish:  
Choose from selected finishes

Wood Base finishes

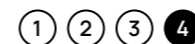
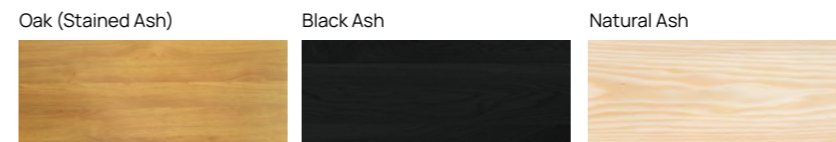

Select Top Type and Finish: All tops are supplied with rounded corners.

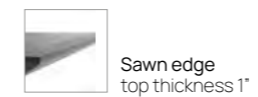
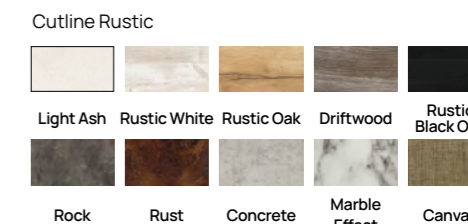
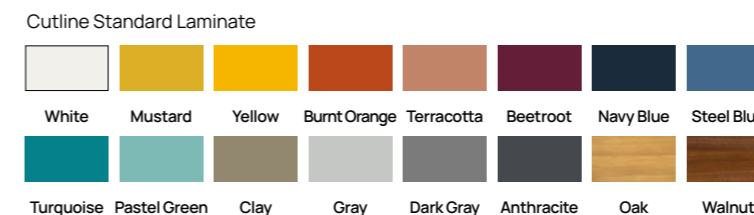
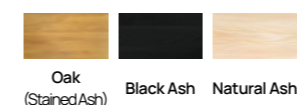
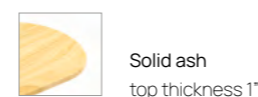



Waterfall edge



Integrated power and data ports



Premium materials

Concealed seamless power flap

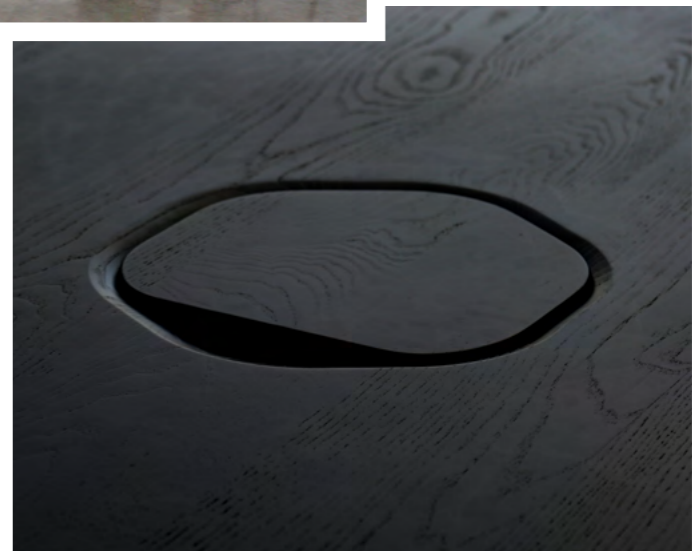



**Isle** Table Dining Height  
height 29, top thickness 1"-1.20"

SIZE (mm)	TOP PIECES	ORDER CODE	PRICE				
			Solid Ash	Cutline Edge			Sawn Edge
				Standard	Rustic	Fenix	
47 x 47	1	IST.DHT.120.120	\$4,742	\$5,173	\$5,575	\$5,976	\$5,173
Power			+\$1,056	+\$1,056	+\$1,056	+\$1,056	+\$1,056



**Isle** Table Dining Height  
height 29, top thickness 1"-1.20"

SIZE (mm)	TOP PIECES	ORDER CODE	PRICE				
			Solid Ash	Cutline Edge			Sawn Edge
				Standard	Rustic	Fenix	
92.5 x 47	1	IST.DHT.235.120	-	-	-	-	\$8,305
110 x 47	2	IST.DHT.280.120	\$10,249	\$8,305	-	\$10,234	-
110 x 59	2	IST.DHT.280.150	\$11,166	-	-	-	-
Power			+\$2,112	+\$2,112	+\$2,112	+\$2,112	+\$2,112



**Isle** Table Dining Height  
height 29, top thickness 1"-1.20"

SIZE (mm)	TOP PIECES	ORDER CODE	PRICE				
			Solid Ash	Cutline Edge			Sawn Edge
				Standard	Rustic	Fenix	
141.5 x 47	2	IST.DHT.360.120	\$14,297	\$13,289	\$13,417	\$13,544	\$13,289
141.5 x 59	2	IST.DHT.360.150	\$15,548	-	-	-	-
165.5 x 47	2	IST.DHT.420.120	\$15,134	\$13,368	\$14,100	\$14,832	\$13,368
165.5 x 59	2	IST.DHT.420.150	\$16,579	-	-	-	-
Power			+\$2,112	+\$2,112	+\$2,112	+\$2,112	+\$2,112



# BLUME

---

Blume is the new addition to our Collaboration category. A contemporary styled range of tables, chairs and stools with sustainability at the heart of their design DNA. With a range of sizes, specifications, and finishes, including a unique Bamboo table finish, the Blume range combines stunning aesthetics with real world functional design details. With sustainability at the core of our business, for every Blume purchased a tree gets planted!



## FEATURES

---

- For every purchase, a tree gets planted
- Wide range of top colors and finishes including our new side-pressed Bamboo top
- Integrated cable management in all table legs with adjustable height levelling feet
- Hand crafted solid ash frame
- Available in a range of sizes
- Optional power and data ports
- Complementary Chairs and Stools
- Rounded corner table top profile



STEPS TO SPECIFY

Follow our guide and customize our products to suit your space

- 1
- 2
- 3
- 4
- 5
- 6
- 7

Select Height: Standard or Bar height

- 1
- 2
- 3
- 4
- 5
- 6
- 7

Select Frame Finish:  
Choose from selected finishes

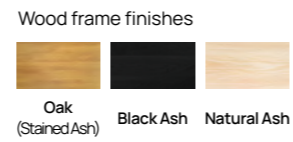

- 1
- 2
- 3
- 4
- 5
- 6
- 7

Select Size:  
Example sizes with chair configurations below, see page 42 for full range of sizes.

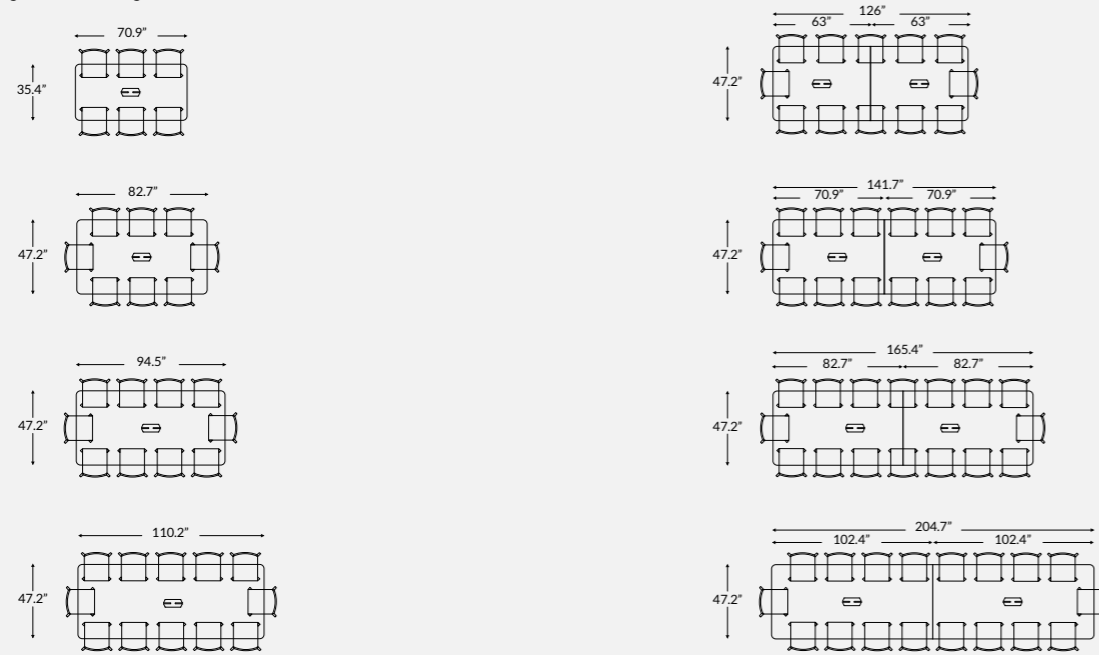

- 1
- 2
- 3
- 4
- 5
- 6
- 7

Select Power: Powered or Non-powered

Blume Tables can be specified with or without integrated power. Tables with Power are supplied with a steel lift-out power flap and shroud for cutline edge laminate tops or a Bamboo power flap to match the table top finish. The cable tray and power modules are Black as standard.

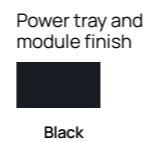

Standard power configuration for Blume Tables with Power

For power variations, the amount of power cut-outs per table varies depending on the length. Power modules per power cut-out are available with one of the options below.

Table Length	Power Cut-outs
63 to 94.5"	1
118 to 248"	2*

**Option A**  
Includes: 4x Power Outlets & 2x Twin USB Charge (1x Type-C & 1x Type-A USB Charge)



**Option B**  
Includes: 4x Power Outlets & 1x Twin USB Charge (1x Type-C & 1x Type-A USB Charge) & 1x HDMI



**Option C** (-\$945 from RRP)  
No power modules. Cable tray only for customers own power.



- 1
- 2
- 3
- 4
- 5
- 6
- 7

Select Top Type and Finish: All tops are supplied with rounded corners. Available with cutline edge laminate or side-pressed solid bamboo.

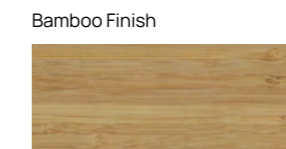
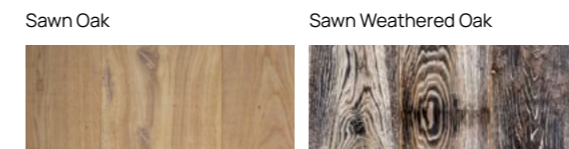
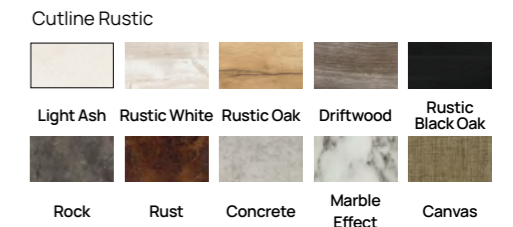

- 1
- 2
- 3
- 4
- 5
- 6
- 7

Select Lift-out Power Flap Finish: Co-ordinating power flap and shroud to match top finish supplied as standard. Other finishes - POA.

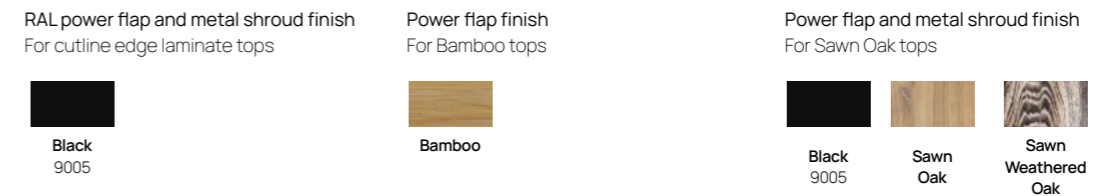

- 1
- 2
- 3
- 4
- 5
- 6
- 7

Select Accessories:

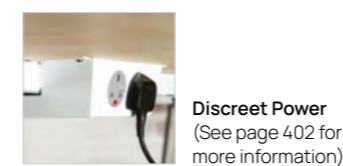



Rounded corner profile tops



Integrated cable management and levelling feet



Complementary Chair and Stool available

Lift-out power flap

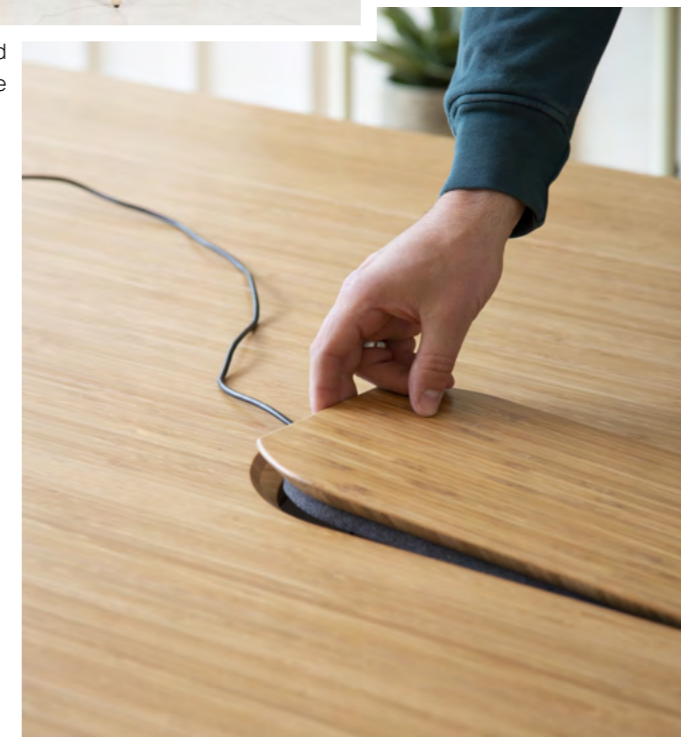



**Blume Table**  
height 29, top thickness 1/1"

SIZE (Inch)	TOP PIECES	ORDER CODE			PRICE				PRICE
					Cutline Rounded Edge				
			Oak (Stained Ash)	Black Ash	Natural Ash	Standard	Rustic	Fenix	Bamboo/Sawn Oak
71 x 35.5	1	BMT.DHT.OCA.180.90.1.NPV	BMT.DHT.SBK.180.90.1.NPV	BMT.DHT.NAS.180.90.1.NPV	\$5,467	\$6,123	\$6,396	\$6,123	
82.5 x 47	1	BMT.DHT.OCA.210.120.1.NPV	BMT.DHT.SBK.210.120.1.NPV	BMT.DHT.NAS.210.120.1.NPV	\$5,599	\$6,272	\$6,552	\$6,272	
94.5 x 47	1	BMT.DHT.OCA.235.120.1.NPV	BMT.DHT.SBK.235.120.1.NPV	BMT.DHT.NAS.235.120.1.NPV	-	-	-	\$6,651	
110 x 47	1	BMT.DHT.OCA.240.120.1.NPV	BMT.DHT.SBK.240.120.1.NPV	BMT.DHT.NAS.240.120.1.NPV	\$5,939	\$6,651	\$6,949	-	
126 x 47	2	BMT.DHT.OCA.320.120.2.NPV	BMT.DHT.SBK.320.120.2.NPV	BMT.DHT.NAS.320.120.2.NPV	\$11,176	\$12,517	\$13,076	\$12,517	
141.5 x 47	2	BMT.DHT.OCA.360.120.2.NPV	BMT.DHT.SBK.360.120.2.NPV	BMT.DHT.NAS.360.120.2.NPV	\$11,528	\$12,911	\$13,488	\$12,911	
165.5 x 47	2	BMT.DHT.OCA.420.120.2.NPV	BMT.DHT.SBK.420.120.2.NPV	BMT.DHT.NAS.420.120.2.NPV	\$12,060	\$13,507	\$14,109	\$13,507	
204.5 x 47	2	BMT.DHT.OCA.520.120.2.NPV	BMT.DHT.SBK.520.120.2.NPV	BMT.DHT.NAS.520.120.2.NPV	\$12,739	\$14,266	\$14,904	\$14,266	



**Blume Table with Power**  
height 29, top thickness 1/1"

SIZE (Inch)	TOP PIECES	CUT-OUTS	ORDER CODE			PRICE				PRICE
						Cutline Edge				
				Oak (Stained Ash)	Black Ash	Natural Ash	Standard	Rustic	Fenix	Bamboo/Sawn Oak
71 x 35.5	1	1	BMT.DHT.OCA.180.90.1.WPV	BMT.DHT.SBK.180.90.1.WPV	BMT.DHT.NAS.180.90.1.WPV	\$6,729	\$7,385	\$7,658	\$7,385	
82.5 x 47	1	1	BMT.DHT.OCA.210.120.1.WPV	BMT.DHT.SBK.210.120.1.WPV	BMT.DHT.NAS.210.120.1.WPV	\$6,861	\$7,534	\$7,814	\$7,534	
94.5 x 47	1	1	BMT.DHT.OCA.235.120.1.WPV	BMT.DHT.SBK.235.120.1.WPV	BMT.DHT.NAS.235.120.1.WPV	-	-	-	\$7,913	
110 x 47	1	1	BMT.DHT.OCA.240.120.1.WPV	BMT.DHT.SBK.240.120.1.WPV	BMT.DHT.NAS.240.120.1.WPV	\$7,201	\$7,913	\$8,211	-	
126 x 47	2	2	BMT.DHT.OCA.320.120.2.WPV	BMT.DHT.SBK.320.120.2.WPV	BMT.DHT.NAS.320.120.2.WPV	\$13,700	\$15,041	\$15,600	\$15,041	
141.5 x 47	2	2	BMT.DHT.OCA.360.120.2.WPV	BMT.DHT.SBK.360.120.2.WPV	BMT.DHT.NAS.360.120.2.WPV	\$14,052	\$15,435	\$16,012	\$15,435	
165.5 x 47	2	2	BMT.DHT.OCA.420.120.2.WPV	BMT.DHT.SBK.420.120.2.WPV	BMT.DHT.NAS.420.120.2.WPV	\$14,584	\$16,031	\$16,633	\$16,031	
204.5 x 47	2	2	BMT.DHT.OCA.520.120.2.WPV	BMT.DHT.SBK.520.120.2.WPV	BMT.DHT.NAS.520.120.2.WPV	\$15,263	\$16,790	\$17,428	\$16,790	



**Blume Bar Height Table**  
height 41.5, top thickness 1/1"

SIZE (Inch)	TOP PIECES	ORDER CODE			PRICE				PRICE
					Cutline Rounded Edge				
			Oak (Stained Ash)	Black Ash	Natural Ash	Standard	Rustic	Fenix	Bamboo/Sawn Oak
71 x 35.5	1	BMT.PHT.OCA.180.90.1.NPV	BMT.PHT.SBK.180.90.1.NPV	BMT.PHT.NAS.180.90.1.NPV	\$5,608	\$6,224	\$7,121	\$6,224	
82.5 x 47	1	BMT.PHT.OCA.210.120.1.NPV	BMT.PHT.SBK.210.120.1.NPV	BMT.PHT.NAS.210.120.1.NPV	\$5,742	\$6,374	\$7,293	\$6,374	
94.5 x 47	1	BMT.PHT.OCA.235.120.1.NPV	BMT.PHT.SBK.235.120.1.NPV	BMT.PHT.NAS.235.120.1.NPV	-	-	-	\$6,374	
110 x 47	1	BMT.PHT.OCA.240.120.1.NPV	BMT.PHT.SBK.240.120.1.NPV	BMT.PHT.NAS.240.120.1.NPV	\$6,082	\$6,750	\$7,723	-	



**Blume Bar Height Table with Power**  
height 41.5, top thickness 1/1"

SIZE (Inch)	TOP PIECES	CUT-OUTS	ORDER CODE			PRICE				PRICE
						Cutline Edge				
				Oak (Stained Ash)	Black Ash	Natural Ash	Standard	Rustic	Fenix	Bamboo/Sawn Oak
71 x 35.5	1	1	BMT.PHT.OCA.180.90.1.WPV	BMT.PHT.SBK.180.90.1.WPV	BMT.PHT.NAS.180.90.1.WPV	\$6,870	\$7,486	\$8,383	\$7,486	
82.5 x 47	1	1	BMT.PHT.OCA.210.120.1.WPV	BMT.PHT.SBK.210.120.1.WPV	BMT.PHT.NAS.210.120.1.WPV	\$7,004	\$7,636	\$8,555	\$7,636	
94.5 x 47	1	1	BMT.PHT.OCA.235.120.1.WPV	BMT.PHT.SBK.235.120.1.WPV	BMT.PHT.NAS.235.120.1.WPV	-	-	-	\$7,636	
110 x 47	1	1	BMT.PHT.OCA.240.120.1.WPV	BMT.PHT.SBK.240.120.1.WPV	BMT.PHT.NAS.240.120.1.WPV	\$7,344	\$8,012	\$8,985	-	

Specify power module option - see page 42 for more information. Price includes cut-out/s in table top, power flap, cable tray and power modules.

Custom cut-out + \$264

**BLUME CHAIR & STOOL - STEPS TO SPECIFY**

Follow our guide and customize our products to suit your space

- 1 2 3 4

Select Height: Chair or Stool

- 1 2 3 4

Select Frame:



- 1 2 3 4

Select Frame Finish: Choose from selected frame finishes

Blume 4 Leg (Wooden frame)

Wood frame finishes

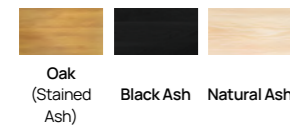

Blume 4 Leg

RAL metal frame finishes

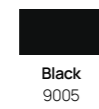

- 1 2 3 4

Select Fabric: Available in limited selected fabrics

Camira - Synergy / Mainline Flax / Blazer

Kvadrat - Remix 3

Other Fabrics - POA

Fabrics

See pages 406-415



**Blume 4 Leg**  
width 23.6, depth 21.5, height 33.3, seat height 18.5"

FABRIC	ORDER CODE	PRICE
1	BMC.4L1.BK.FBB	\$1,067
2	BMC.4L1.BK.FBC	\$1,109

Other Fabric Bands - POA



**Blume Stool 4 Leg**  
width 22.4, depth 24, height 40.2, seat height 29.1"

FABRIC	ORDER CODE	PRICE
1	BMS.4L1.BK.FBB	\$1,408
2	BMS.4L1.BK.FBC	\$1,454

Other Fabric Bands - POA

\*counterheight available upon request



**Blume 4 Leg (Wooden frame)**  
width 20, depth 19.5, height 33.5, seat height 18.5"

FABRIC	ORDER CODE			PRICE
	Oak (Stained Ash)	Black Ash	Natural Ash	
1	BMC.4W1.OCA.FBB	BMC.4W1.SBA.FBB	BMC.4W1.NAS.FBB	\$1,801
2	BMC.4W1.OCA.FBC	BMC.4W1.SBA.FBC	BMC.4W1.NAS.FBC	\$1,842

Other Fabric Bands - POA



**Blume Stool 4 Leg (Wooden frame)**  
width 19.5, depth 19.5, height 40.5, seat height 29.5"

FABRIC	ORDER CODE			PRICE
	Oak (Stained Ash)	Black Ash	Natural Ash	
1	BMS.4W1.OCA.FBB	BMS.4W1.SBA.FBB	BMS.4W1.NAS.FBB	\$2,130
2	BMS.4W1.OCA.FBC	BMS.4W1.SBA.FBC	BMS.4W1.NAS.FBC	\$2,174

Other Fabric Bands - POA



# RELIC PROJECT TABLE

Designed for flexible co-working spaces, the Relic Project Table is an exciting evolution in the Relic design family. The height of the Relic Project Table can be electronically adjusted at the simple flick of a switch to create the ideal workstation for any task. Using market-leading lifting columns and discreetly hidden power cables, the Relic Project Table has the ability to adjust with ease from desk height to bar height without compromising its beautiful sleek style.



## FEATURES

- Height adjustable electric table
- Smart technology with app compatibility
- Ideal for collaboration & flexible workspaces
- Available in 4 sizes
- Optional castors for mobility
- Choose from a wide range of colors
- Large capacity power bank with ability to extend
- Optional rechargeable battery



Scan to watch video



STEPS TO SPECIFY

Follow our guide and customize our products to suit your space

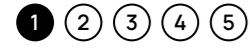

Select Format: Rectangle, Square or Round

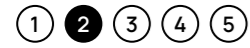

Select Frame: Adjustable feet or Castors

Black frame finish as standard. Other Frövi RAL frame finishes available - POA.

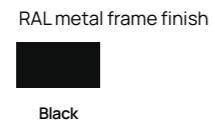

Adjustable Feet Castors





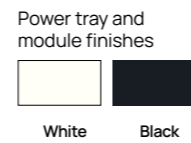

Select Power in Top: Powered or Non-powered

Relic Project Tables can be specified with or without integrated power in the top. Tables with Power are supplied with one or more steel lift-out power flaps that match the selected frame color. The cable tray and power modules are White as standard but are available in Black on request.



Standard power configuration for Relic Project Tables with Power

Power modules are available with one of the options below.

<p><b>Option A</b></p> <p>4x Power Outlet &amp; 2x Twin USB Charge (1x Type-C &amp; 1x Type-A USB Charge)</p> 	<p><b>Option B</b></p> <p>4x Power Outlet, 1x Twin USB Charge (1x Type-C &amp; 1x Type-A), 1x CAT6 &amp; 1x HDMI</p> 	<p><b>Option C</b></p> <p>4x Power Outlet, 1x Twin USB Charge (1x Type-C &amp; 1x Type-A) &amp; 2x CAT6</p> 	<p><b>Option D</b> (-\$945 from RRP)</p> <p>No power modules. Cable tray only for customers own power.</p> 
---	--	--	--

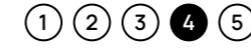

Select Top Finish: Outline edge laminate



Cutline Standard Laminate

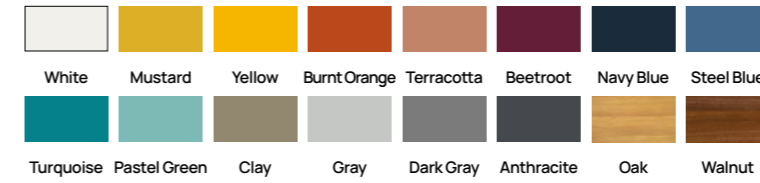

Cutline Fenix



Cutline Rustic

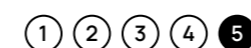
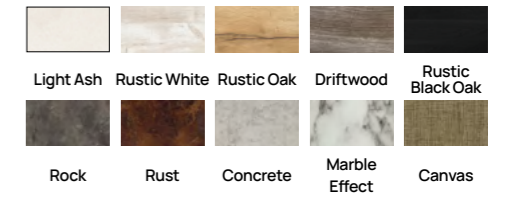

Select Accessories:

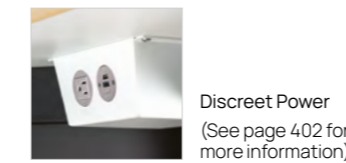

Discreet Power (See page 402 for more information)



Rechargeable Battery Allows 40 table adjustments in one charge



**Relic Project Table**  
height 29.5 - 41.5"

SIZE (Inch)	ORDER CODE	PRICE		
	Cutline Edge	Standard	Rustic	Fenix
82.5 x 47	RSHA.BK.2112R.1	\$13,935	\$14,500	\$15,417
110 x 47	RSHA.BK.2812R.1	\$14,289	-	\$15,771



**Relic Project Table with Castors**  
height 29.5 - 41.5"

SIZE (Inch)	ORDER CODE	PRICE		
	Cutline Edge	Standard	Rustic	Fenix
82.5 x 47	RSHA.BK.2112R.1.WCA	\$14,316	\$14,881	\$15,796
110 x 47	RSHA.BK.2812R.1.WCA	\$14,668	-	\$16,150



**Relic Project Table with Power**  
height 29.5 - 41.5"

SIZE (Inch)	ORDER CODE	PRICE		
	Cutline Edge	Standard	Rustic	Fenix
82.5 x 47	RSHA.BK.2112R.1.WPV/BK	\$18,200	\$18,865	\$19,942
110 x 47	RSHA.BK.2812R.1.WPV/BK	\$18,616	-	\$20,358



**Relic Project Table with Power and Castors**  
height 29.5 - 41.5"

SIZE (Inch)	ORDER CODE	PRICE		
	Cutline Edge	Standard	Rustic	Fenix
82.5 x 47	RSHA.BK.2112R.1.WPV/BK.WCA	\$18,647	\$19,312	\$20,389
110 x 47	RSHA.BK.2812R.1.WPV/BK.WCA	\$19,063	-	\$20,805



**Relic Project Square Table**  
height 29.5 - 41.5"

SIZE (Inch)	ORDER CODE	PRICE		
	Cutline Edge	Standard	Rustic	Fenix
63 x 63"	RSHA.BK.1616S.2	\$14,876	\$16,090	\$17,388



**Relic Project Square Table with Castors**  
height 29.5 - 41.5"

SIZE (Inch)	ORDER CODE	PRICE		
	Cutline Edge	Standard	Rustic	Fenix
63 x 63"	RSHA.BK.1616S.2.WCA	\$15,257	\$16,473	\$17,769



**Relic Project Square Table with Power**  
height 29.5 - 41.5"

SIZE (Inch)	ORDER CODE	PRICE		
	Cutline Edge	Standard	Rustic	Fenix
63 x 63"	RSHA.BK.1616S.2.WPV/BK	\$19,307	\$20,735	\$22,262



**Relic Project Square Table with Power and Castors**  
height 29.5 - 41.5"

SIZE (Inch)	ORDER CODE	PRICE		
	Cutline Edge	Standard	Rustic	Fenix
63 x 63"	RSHA.BK.1616S.2.WPV/BK.WCA	\$19,754	\$21,184	\$22,709



**Relic Project Round Table**  
height 29.5 - 41.5"

SIZE (Inch)	ORDER CODE	PRICE		
	Cutline Edge	Standard	Rustic	Fenix
71 dia	RSHA.BK.180D.2	\$16,641	\$18,379	\$20,260



**Relic Project Round Table with Castors**  
height 29.5 - 41.5"

SIZE (Inch)	ORDER CODE	PRICE		
	Cutline Edge	Standard	Rustic	Fenix
71 dia	RSHA.BK.180D.2.WCA	\$17,020	\$18,758	\$20,643



**Relic Project Round Table with Power**  
height 29.5 - 41.5"

SIZE (Inch)	ORDER CODE	PRICE		
	Cutline Edge	Standard	Rustic	Fenix
71 dia	RSHA.BK.180D.2.WPV/BK	\$21,383	\$23,427	\$25,640



**Relic Project Round Table with Power and Castors**  
height 29.5 - 41.5"

SIZE (Inch)	ORDER CODE	PRICE		
	Cutline Edge	Standard	Rustic	Fenix
71 dia	RSHA.BK.180D.2.WPV/BK.WCA	\$21,830	\$23,874	\$26,090

Optional rechargeable power pack for mobile tables (PRSHABT) - \$780

# RELIC AT WORK

---

Relic at Work is a co-working system derived from our current Relic design. The unique wedge shape tops are designed to allow a generous work space with a compact footprint. Adjustment between a collaborative work space and private working can be achieved with the use of the additional, magnetically attached accessories. Adding a canopy and lighting will soften the environment, with an option to also specify biophilia.



## FEATURES

---

- Multi-functional workspace for co-working or personal use
- Optional castors for mobility
- Large capacity power bank with 8 Power Outlet sockets (4 per user). Ability to extend capacity
- Offset seating positions
- Overhead acoustic canopy
- Hanging trays for storage or plants
- Wedge-shaped tops to maximise space and minimise footprint
- Magnetic accessories for re-positioning



Scan to watch video

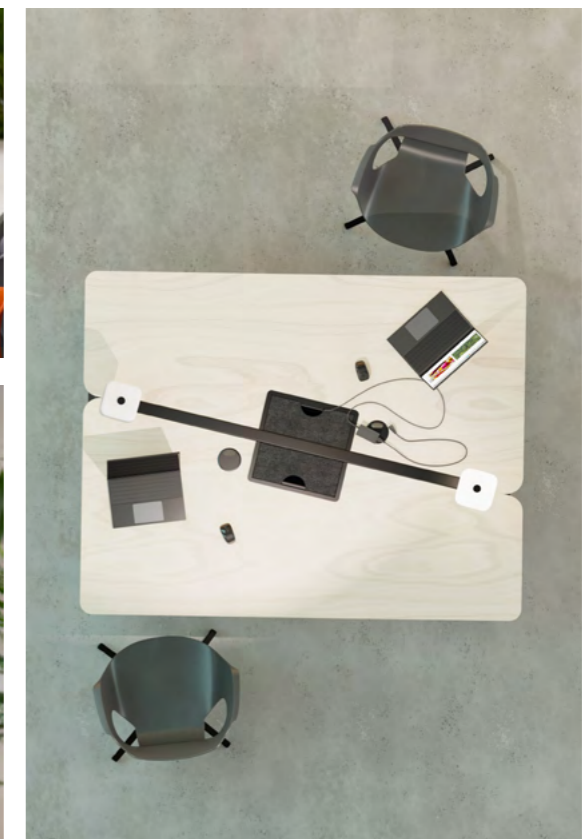

STEPS TO SPECIFY

Follow our guide and customize our products to suit your space

- 1
- 2
- 3
- 4

Select Frame: Standard or Canopy, with or without Castors.  
Extension Table with intermediate frame also available.



RAL metal frame finish



Black

- 1
- 2
- 3
- 4

Select Top Finish:



MFC - 1"



White Rustic Oak

Laminate Rustic - 1"

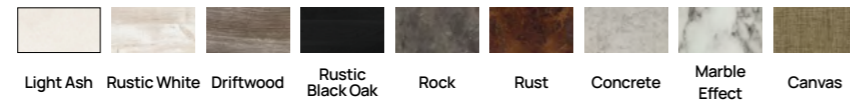

Light Ash Rustic White Driftwood Rustic Black Oak Rock Rust Concrete Marble Effect Canvas

- 1
- 2
- 3
- 4

Select Felt Finish: (if applicable) Canopy and Desk Screen.

Felt Finishes



Gray Dark Gray

- 1
- 2
- 3
- 4

Select Accessories: All accessories are available in Black finish only unless stated.

DESK ACCESSORIES



Magnetic Desk/Storage Planter



Magnetic Felt Screen  
Available in Gray and Dark Gray



Solo Power Unit  
1x Power Outlet & 1x Twin USB Charge.  
(1x Type-C & 1x Type-A)  
Available in Black  
Max 2 per table

CANOPY ACCESSORIES

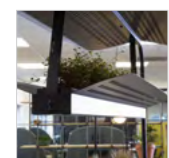

Hanging Planter  
Hooks can be removed to create a desk planter



Hanging Tray



Canopy Multi-purpose Pot  
Lined terracotta pot

Relic at Work Tables are specified with integrated power as standard.  
For additional or alternative power, positioned underneath the top, please refer to our Discreet Power option on page 380.  
Relic at Work Tables are supplied with 2 black felt lift-out power flaps. The cable tray and power modules are in Black finish.  
Additional cut-outs in cable tray for secondary power options. Other custom power configurations available on request.



Power supplied as standard: 8x Power Outlet - with two additional recesses for extra power

Additional Power: Add an extra 8 x Power Outlet modules  
\$575



Cable Port  
Available in Black  
Supplied as standard with 3.15" dia hole pre-drilled table top. Can be replaced by Solo Power Unit.  
Max 2 per table.





All versions available with castors



Integrated cable management with table power options

Magnetic Desk/Storage Planter



Multiple accessories





**Relic at Work** Table with Canopy  
width 71, depth 55, height 78"

DESCRIPTION	ORDER CODE	PRICE	
		MFC	Laminate
Table with Canopy	RSAW.RAWT/C.BK	\$7,626	\$9,437



**Relic at Work** Table with Canopy on Castors  
width 71, depth 55, height 78"

DESCRIPTION	ORDER CODE	PRICE	
		MFC	Laminate
Table with Canopy on Castors	RSAW.RAWMT/C.BK	\$7,959	\$9,783



**Relic at Work** Table  
width 71, depth 55, height 29.5"

DESCRIPTION	ORDER CODE	PRICE	
		MFC	Laminate
Table	RSAW.RAWT.BK	\$6,201	\$8,012



**Relic at Work** Table on Castors  
width 71, depth 55, height 29.5"

DESCRIPTION	ORDER CODE	PRICE	
		MFC	Laminate
Table on Castors	RSAW.RAWMT.BK	\$6,534	\$8,358

**Relic at Work** Table (Extension)  
width 71, depth 55, height 29.5"

DESCRIPTION	ORDER CODE	PRICE	
		MFC	Laminate
Extension Table	RSAW.RAWE.BK	\$5,718	\$7,515

**Relic at Work** Table on Castors (Extension)  
width 71, depth 55, height 29.5"

DESCRIPTION	ORDER CODE	PRICE	
		MFC	Laminate
Extension Table on Castors	RSAW.RAWME.BK	\$5,871	\$7,662

**Relic at Work** Accessories

DESCRIPTION	ORDER CODE	PRICE	
<b>Desk Accessories</b>			
Magnetic Storage/Planter	RAWPBK	\$434	
Magnetic Felt Screen	RAWS.BK	\$477	
Solo Power Unit	SO80.SP1	\$571	

DESCRIPTION	ORDER CODE	PRICE	
<b>Canopy Accessories</b>			
Hanging Planter	RAWCDPBK	\$821	
Hanging Tray	RAWHT.BK	\$215	
Multi-purpose Pot	RAWCPC.BK	\$147	

To construct a run of tabletops add a standard table and the number of extension tables required to create your run of tables.  
Note: The extension table cannot be used with canopy table.



Standard 70.8" Table on Castors

+



Extension 70.8" Table on Castors

=



141.7" Table on Castors run

# RELIC

---

This flexible range is a natural choice for any co-working environment. Choose mobile table variations to create collaborative spaces for agile working and social exchange. A fusion of rustic detail and industrial inspiration, the extensive range of sizes and finishes enables Relic to be used in multiple applications across every scheme.



## FEATURES

---

- Wide range of sizes and finishes
- Power and data port options
- Fully integrated cable management
- Inset frame allows additional seating at either end
- Castors available for mobility
- Complementary benches, stools and storage
- Fast assembly





STEPS TO SPECIFY

Follow our guide and customize our products to suit your space

- 1 2 3 4 5 6

Select Frame: Standard or Bar height, with or without Castors

- 1 2 3 4 5 6

Select Size:  
Example sizes with chair configurations below, see page 66 for full range of sizes.

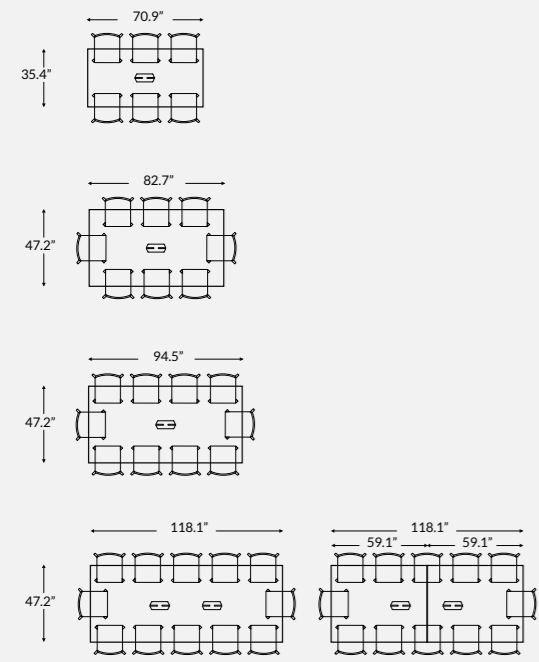

Diagrams show a 19.6" chair placed around the tables as seating capacity indication only. Capacity can be increased with the use of benches. Tables over 118.1" are more than one-piece tops, seams as shown below.

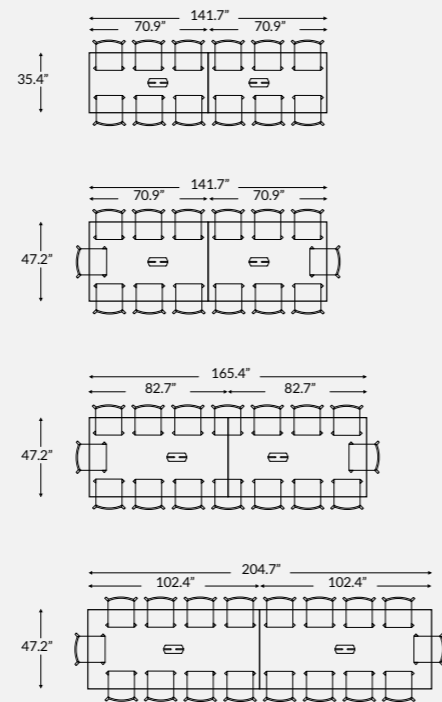

- 1 2 3 4 5 6

Select Power: Powered or Non-powered

Relic Tables can be specified with or without integrated power. Tables with Power are supplied with one or more steel lift-out power flaps that match the selected frame color. The cable tray and power modules are White as standard but are available in Black on request.

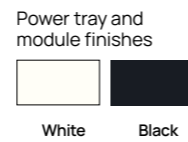

Standard power configuration for Relic Tables with Power

For power variations, the amount of power cut-outs per table varies depending on the length. Power modules per power cut-out are available with one of the options below.

Table Length	Power Cut-outs
63 to 94.5"	1
118.1 to 248"	2*

Option A

Includes: 4x Power Outlets & 2x Twin USB Charge (1x Type-C & 1x Type-A USB Charge)



Option B

Includes: 4x Power Outlets & 1x Twin USB Charge (1x Type-C & 1x Type-A USB Charge) & 1x HDMI



Option C

(-\$1,262 from RRP)

No power modules. Cable tray only for customers own power.



- 1 2 3 4 5 6

Select Frame Finish: RAL, Vintage or Raw Steel

RAL metal frame finishes

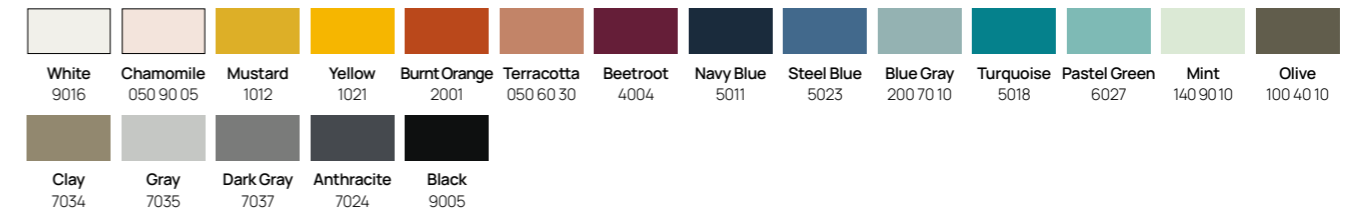

Vintage metal frame finishes

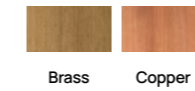

Metal frame finishes



- 1 2 3 4 5 6

Select Top Type and Finish: Outline edge laminate or Sawn Oak



Outline Standard Laminate



Outline Fenix



Outline Rustic

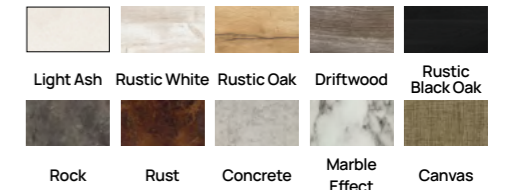

Sawn Oak

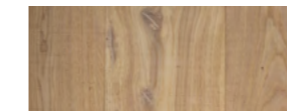

Sawn Weathered Oak



- 1 2 3 4 5 6

Select Accessories:

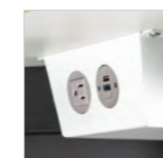

Discreet Power  
(See page 402 for more information)



Complementing Stools and Benches



Braking castors



Lift-out power flap



Integrated cable management and levelling feet





**Relic Table**  
height 29.5"

SIZE (Inch)	TOP PIECES	ORDER CODE	PRICE						PRICE	
			Cutline Edge		Rustic		Fenix		Sawn Top	
			Standard	Vintage	RAL/Raw	Vintage	RAL/Raw	Vintage	RAL/Raw	Vintage
		<b>Frame Finish:</b>	RAL/Raw	Vintage	RAL/Raw	Vintage	RAL/Raw	Vintage	RAL/Raw	Vintage
55 x 31.5	1	RST.140.80.1	\$3,376	\$4,811	\$4,372	\$5,697	\$5,363	\$6,688	\$4,372	\$5,697
55 x 35.5	1	RST.140.90.1	\$3,399	\$4,836	\$4,515	\$5,748	\$5,384	\$6,750	\$4,515	\$5,748
55 x 47	1	RST.140.120.1	\$3,511	\$4,964	\$4,875	\$6,100	\$5,744	\$7,133	\$4,875	\$6,100
63 x 31.5	1	RST.160.80.1	\$3,459	\$4,891	\$4,568	\$5,893	\$5,684	\$7,009	\$4,568	\$5,893
63 x 35.5	1	RST.160.90.1	\$3,519	\$4,925	\$4,796	\$5,966	\$5,831	\$7,183	\$4,796	\$5,966
63 x 47	1	RST.160.120.1	\$3,633	\$5,051	\$5,063	\$6,181	\$6,183	\$7,386	\$5,063	\$6,181
71 x 31.5	1	RST.180.80.1	\$3,548	\$4,978	\$4,775	\$6,100	\$6,011	\$7,330	\$4,775	\$6,100
71 x 35.5	1	RST.180.90.1	\$3,612	\$5,047	\$4,813	\$6,138	\$6,073	\$7,342	\$4,813	\$6,138
71 x 47	1	RST.180.120.1	\$3,863	\$5,274	\$5,192	\$6,444	\$6,293	\$7,601	\$5,192	\$6,444
82.5 x 35.5	1	RST.210.90.1	\$3,813	\$5,161	\$4,922	\$6,067	\$6,258	\$7,423	\$4,922	\$6,067
82.5 x 47	1	RST.210.120.1	\$3,999	\$5,432	\$5,295	\$6,581	\$6,380	\$7,640	\$5,297	\$6,581
92.5 x 35.5	1	RST.235.90.1	-	-	-	-	-	-	\$5,018	\$6,332
92.5 x 47	1	RST.235.120.1	-	-	-	-	-	-	\$5,440	\$6,705
94.5 x 35.5	1	RST.240.90.1	\$3,960	\$5,351	\$5,018	\$6,332	\$6,266	\$7,469	-	-
94.5 x 47	1	RST.240.120.1	\$4,221	\$5,659	\$5,440	\$6,705	\$6,545	\$7,700	-	-
118 x 35.5	1	RST.300.90.1	\$4,850	\$5,579	-	-	\$6,440	\$7,645	-	-
118 x 47	1	RST.300.120.1	\$5,119	\$6,578	-	-	\$6,817	\$7,901	-	-
118 x 35.5	2	RST.300.90.2	\$6,920	\$9,342	\$8,212	\$10,569	\$11,188	\$13,273	\$8,212	\$10,569
118 x 47	2	RST.300.120.2	\$7,121	\$9,613	\$8,651	\$10,836	\$11,563	\$14,117	\$8,651	\$10,836
126 x 35.5	2	RST.320.90.2	\$7,042	\$9,476	\$8,522	\$10,741	\$11,499	\$13,486	\$8,522	\$10,741
126 x 47	2	RST.320.120.2	\$7,305	\$9,756	\$9,112	\$11,203	\$11,820	\$14,266	\$9,112	\$11,203
141.5 x 35.5	2	RST.360.90.2	\$7,214	\$9,605	\$9,031	\$11,151	\$11,803	\$13,917	\$9,031	\$11,151
141.5 x 47	2	RST.360.120.2	\$7,423	\$9,814	\$9,503	\$11,422	\$11,865	\$14,571	\$9,503	\$11,422
149.5 x 35.5	2	RST.380.90.2	\$7,361	\$9,698	\$9,427	\$11,209	\$12,004	\$14,349	\$9,427	\$11,209
149.5 x 47	2	RST.380.120.2	\$7,831	\$10,149	\$10,002	\$11,745	\$12,290	\$14,925	\$10,002	\$11,745
165.5 x 35.5	2	RST.420.90.2	\$7,721	\$9,990	\$9,835	\$11,611	\$12,172	\$14,842	\$9,835	\$11,611
165.5 x 47	2	RST.420.120.2	\$8,417	\$10,563	\$10,445	\$12,194	\$12,828	\$15,179	\$10,445	\$12,194
185 x 35.5	2	RST.470.90.2	-	-	-	-	-	-	\$10,230	\$12,070
185 x 47	2	RST.470.120.2	-	-	-	-	-	-	\$10,661	\$13,074
189 x 35.5	2	RST.480.90.2	\$8,373	\$10,441	\$10,230	\$12,070	\$12,753	\$14,966	-	-
189 x 47	2	RST.480.120.2	\$8,967	\$11,012	\$10,661	\$13,074	\$12,944	\$15,304	-	-
204.5 x 35.5	2	RST.520.90.2	\$8,802	\$10,890	\$10,530	\$12,867	\$12,712	\$15,092	-	-
204.5 x 47	2	RST.520.120.2	\$9,156	\$11,493	\$10,810	\$13,265	\$13,062	\$15,430	-	-
212.5 x 35.5	3	RST.540.90.3	\$10,617	\$12,975	\$12,681	\$14,838	\$13,548	\$16,132	\$12,681	\$14,838
212.5 x 47	3	RST.540.120.3	\$13,039	\$15,401	\$15,227	\$17,603	\$16,717	\$19,224	\$15,227	\$17,603
236 x 35.5	3	RST.600.90.3	\$11,484	\$13,848	\$13,352	\$15,709	\$14,591	\$16,953	\$13,352	\$15,709
236 x 47	3	RST.600.120.3	\$14,035	\$16,392	\$15,833	\$18,197	\$17,699	\$20,062	\$15,833	\$18,197
248 x 35.5	3	RST.630.90.3	\$11,766	\$14,128	\$13,747	\$16,158	\$14,904	\$17,268	\$13,749	\$16,158
248 x 47	3	RST.630.120.3	\$14,442	\$16,802	\$16,285	\$18,694	\$18,009	\$20,373	\$16,285	\$18,694



**Relic Bar Height Table**  
height 41.5"

SIZE (Inch)	TOP PIECES	ORDER CODE	PRICE						PRICE	
			Cutline Edge		Rustic		Fenix		Sawn Top	
			Standard	Vintage	RAL/Raw	Vintage	RAL/Raw	Vintage	RAL/Raw	Vintage
		<b>Frame Finish:</b>	RAL/Raw	Vintage	RAL/Raw	Vintage	RAL/Raw	Vintage	RAL/Raw	Vintage
55 x 31.5	1	RSP140.80.1	\$3,629	\$4,993	\$4,560	\$5,887	\$5,552	\$6,879	\$4,560	\$5,887
55 x 35.5	1	RSP140.90.1	\$3,664	\$5,028	\$4,672	\$5,960	\$5,620	\$6,978	\$4,672	\$5,960
55 x 47	1	RSP140.120.1	\$3,782	\$5,262	\$4,978	\$6,175	\$6,024	\$7,338	\$4,978	\$6,175
63 x 31.5	1	RSP160.80.1	\$3,705	\$5,069	\$4,763	\$6,086	\$5,873	\$7,202	\$4,763	\$6,086
63 x 35.5	1	RSP160.90.1	\$3,755	\$5,115	\$4,858	\$6,181	\$5,999	\$7,320	\$4,858	\$6,181
63 x 47	1	RSP160.120.1	\$3,838	\$5,351	\$5,113	\$6,309	\$6,396	\$7,500	\$5,113	\$6,309
71 x 31.5	1	RSP180.80.1	\$3,790	\$5,161	\$4,966	\$6,287	\$6,196	\$7,524	\$4,966	\$6,287
71 x 35.5	1	RSP180.90.1	\$3,858	\$5,229	\$5,001	\$6,324	\$6,206	\$7,533	\$5,001	\$6,324
71 x 47	1	RSP180.120.1	\$4,183	\$5,494	\$5,247	\$6,539	\$6,494	\$7,785	\$5,247	\$6,539
82.5 x 35.5	1	RSP210.90.1	\$3,966	\$5,361	\$5,086	\$6,415	\$6,463	\$7,543	\$5,086	\$6,415
82.5 x 47	1	RSP210.120.1	\$4,241	\$5,612	\$5,347	\$6,657	\$6,599	\$7,816	\$5,347	\$6,657
92.5 x 35.5	1	RSP235.90.1	-	-	-	-	-	-	\$5,229	\$6,537
92.5 x 47	1	RSP235.120.1	-	-	-	-	-	-	\$5,465	\$6,814
94.5 x 35.5	1	RSP240.90.1	\$4,032	\$5,500	\$5,229	\$6,537	\$6,469	\$7,597	-	-
94.5 x 47	1	RSP.240.120.1	\$4,463	\$5,842	\$5,465	\$6,814	\$6,752	\$7,876	-	-
118 x 35.5	1	RSP300.90.1	\$5,096	\$5,775	-	-	\$6,655	\$7,829	-	-
118 x 47	1	RSP300.120.1	\$5,361	\$6,761	-	-	\$7,030	\$8,098	-	-
118 x 35.5	2	RSP300.90.2	\$7,355	\$9,617	\$8,557	\$11,724	\$11,760	\$13,763	\$8,557	\$10,569
118 x 47	2	RSP300.120.2	\$7,566	\$9,895	\$8,990	\$12,004	\$12,018	\$14,376	\$8,990	\$10,836
126 x 35.5	2	RSP320.90.2	\$7,413	\$9,814	\$8,874	\$11,865	\$11,803	\$14,329	\$8,874	\$10,741
126 x 47	2	RSP320.120.2	\$7,783	\$10,095	\$9,522	\$12,648	\$12,178	\$14,629	\$9,522	\$11,203
141.5 x 35.5	2	RSP360.90.2	\$7,729	\$9,986	\$9,427	\$12,538	\$12,165	\$14,618	\$9,427	\$11,151
141.5 x 47	2	RSP360.120.2	\$7,934	\$10,199	\$9,876	\$12,803	\$12,227	\$14,674	\$9,876	\$11,422
149.5 x 35.5	2	RSP380.90.2	\$7,839	\$10,093	\$9,806	\$12,615	\$12,172	\$14,645	\$9,806	\$11,209
149.5 x 47	2	RSP380.120.2	\$8,315	\$10,317	\$10,387	\$12,851	\$12,443	\$15,361	\$10,387	\$11,745
165.5 x 35.5	2	RSP420.90.2	\$8,272	\$10,151	\$10,195	\$12,884	\$12,406	\$15,287	\$10,195	\$11,611
165.5 x 47	2	RSP420.120.2	\$8,930	\$11,211	\$10,807	\$13,260	\$13,161	\$15,631	\$10,807	\$12,194
185 x 35.5	2	RSP470.90.2	-	-	-	-	-	-	\$10,677	\$12,070
185 x 47	2	RSP470.120.2	-	-	-	-	-	-	\$11,021	\$13,074
189 x 35.5	2	RSP480.90.2	\$8,798	\$10,743	\$10,677	\$13,082	\$13,087	\$15,422	-	-
189 x 47	2	RSP480.120.2	\$9,412	\$11,724	\$11,021	\$13,469	\$13,277	\$15,755	-	-
204.5 x 35.5	2	RSP520.90.2	\$9,240	\$11,569	\$10,859	\$13,281	\$13,066	\$15,552	-	-
204.5 x 47	2	RSP520.120.2	\$9,667	\$11,965	\$11,172	\$13,621	\$13,393	\$15,887	-	-
212.5 x 35.5	3	RSP540.90.3	\$11,213	\$13,577	\$13,451	\$15,809	\$14,322	\$16,682	\$13,451	\$14,838
212.5 x 47	3	RSP540.120.3	\$13,637	\$15,999	\$15,999	\$18,359	\$17,489	\$19,851	\$15,999	\$17,603
236 x 35.5	3	RSP600.90.3	\$12,145	\$14,507	\$14,010	\$16,372	\$15,252	\$17,614	\$14,010	\$15,709
236 x 47	3	RSP600.120.3	\$14,695	\$17,053	\$16,496	\$18,854	\$18,359	\$20,723	\$16,496	\$18,197
248 x 35.5	3	RSP630.90.3	\$12,488	\$14,848	\$14,256	\$16,620	\$15,691	\$18,048	\$14,256	\$16,158
248 x 47	3	RSP630.120.3	\$15,161	\$17,523	\$16,746	\$19,102	\$18,796	\$21,155	\$16,746	\$18,694

Specify power module option - see page 66 for more information. Price includes cut-out/s in table top, power flap, cable tray and power modules.

Shroud and power flap in a contrasting finish to framework RAL/Raw: + \$203 Vintage: + \$406 Custom cut-out + \$185



**Relic Table with Power**  
height 29.5"

SIZE (Inch)	TOP PIECES	CUT-OUTS	ORDER CODE	PRICE						PRICE												
				Cutline Edge		Rustic		Fenix		Sawn Top												
				Standard	Vintage	RAL/Raw	Vintage	RAL/Raw	Vintage	RAL/Raw	Vintage	RAL/Raw	Vintage	RAL/Raw	Vintage							
			<b>Frame Finish:</b>																			
63 x 31.5	1	1	RST.160.80.1.WPV	\$4,638	\$6,073	\$5,634	\$6,959	\$6,625	\$9,950	\$5,634	\$6,959											
63 x 35.5	1	1	RST.160.90.1.WPV	\$4,661	\$6,098	\$5,777	\$7,010	\$6,646	\$8,012	\$5,777	\$7,010											
63 x 47	1	1	RST.160.120.1.WPV	\$4,773	\$6,226	\$6,137	\$7,362	\$7,006	\$8,395	\$6,137	\$7,362											
71 x 31.5	1	1	RST.180.80.1.WPV	\$4,721	\$6,153	\$5,830	\$7,155	\$6,946	\$8,271	\$5,830	\$7,155											
71 x 35.5	1	1	RST.180.90.1.WPV	\$4,781	\$6,187	\$6,058	\$7,228	\$7,093	\$8,445	\$6,058	\$7,228											
71 x 47	1	1	RST.180.120.1.WPV	\$4,895	\$6,313	\$6,325	\$7,443	\$7,445	\$8,648	\$6,325	\$7,443											
82.5 x 35.5	1	1	RST.210.90.1.WPV	\$4,810	\$6,240	\$6,037	\$7,362	\$7,273	\$8,592	\$6,037	\$7,362											
82.5 x 47	1	1	RST.210.120.1.WPV	\$4,874	\$6,309	\$6,075	\$7,400	\$7,335	\$8,604	\$6,075	\$7,400											
92.5 x 35.5	1	1	RST.235.90.1.WPV	\$5,125	\$6,536	\$6,454	\$7,706	\$7,555	\$8,863	\$6,454	\$7,706											
92.5 x 47	1	1	RST.235.120.1.WPV	\$5,075	\$6,423	\$6,184	\$7,329	\$7,520	\$8,685	\$6,184	\$7,329											
94.5 x 35.5	1	1	RST.240.90.1.WPV	\$5,261	\$6,694	\$6,557	\$7,843	\$7,642	\$8,902	\$6,559	\$7,843											
94.5 x 47	1	1	RST.240.120.1.WPV	-	-	-	-	-	-	\$6,280	\$7,594											
118 x 35.5	1	2	RST.300.90.1.WPV	-	-	-	-	-	-	\$6,702	\$7,967											
118 x 47	1	2	RST.300.120.1.WPV	\$5,222	\$6,613	\$6,280	\$7,594	\$7,528	\$8,731	-	-											
118 x 35.5	2	2	RST.300.90.2.WPV	\$5,483	\$6,921	\$6,702	\$7,967	\$7,807	\$8,962	-	-											
118 x 47	2	2	RST.300.120.2.WPV	\$6,112	\$6,841	-	-	\$7,702	\$8,907	-	-											
126 x 35.5	2	2	RST.320.90.2.WPV	\$6,381	\$7,840	-	-	\$8,079	\$9,163	-	-											
126 x 47	2	2	RST.320.120.2.WPV	\$8,182	\$10,604	\$9,474	\$11,831	\$12,450	\$14,535	\$9,474	\$11,831											
141.5 x 35.5	2	2	RST.360.90.2.WPV	\$8,383	\$10,875	\$9,913	\$12,098	\$12,825	\$15,379	\$9,913	\$12,098											
141.5 x 47	2	2	RST.360.120.2.WPV	\$8,304	\$10,738	\$9,784	\$12,003	\$12,761	\$14,748	\$9,784	\$12,003											
149.5 x 35.5	2	2	RST.380.90.2.WPV	\$8,567	\$11,018	\$10,374	\$12,465	\$13,082	\$15,528	\$10,374	\$12,465											
149.5 x 47	2	2	RST.380.120.2.WPV	\$8,476	\$10,867	\$10,293	\$12,413	\$13,065	\$15,179	\$10,293	\$12,413											
165.5 x 35.5	2	2	RST.420.90.2.WPV	\$8,685	\$11,076	\$10,765	\$12,684	\$13,127	\$15,833	\$10,765	\$12,684											
165.5 x 47	2	2	RST.420.120.2.WPV	\$8,623	\$10,960	\$10,689	\$12,471	\$13,266	\$15,611	\$10,689	\$12,471											
185 x 35.5	2	2	RST.470.90.2.WPV	\$9,093	\$11,411	\$11,264	\$13,007	\$13,552	\$16,187	\$11,264	\$13,007											
185 x 47	2	2	RST.470.120.2.WPV	\$8,983	\$11,252	\$11,097	\$12,873	\$13,434	\$16,104	\$11,097	\$12,873											
189 x 35.5	2	2	RST.480.90.2.WPV	\$9,679	\$11,825	\$11,707	\$13,456	\$14,090	\$16,441	\$11,707	\$13,456											
189 x 47	2	2	RST.480.120.2.WPV	-	-	-	-	-	-	\$11,492	\$13,332											
204.5 x 35.5	2	2	RST.520.90.2.WPV	-	-	-	-	-	-	\$11,923	\$14,336											
204.5 x 47	2	2	RST.520.120.2.WPV	\$9,635	\$11,703	\$11,492	\$13,332	\$14,015	\$16,228	-	-											
212.5 x 35.5	3	2	RST.540.90.3.WPV	\$10,229	\$12,274	\$11,923	\$14,336	\$14,206	\$16,566	-	-											
212.5 x 47	3	2	RST.540.120.3.WPV	\$10,064	\$12,152	\$11,792	\$14,129	\$13,974	\$16,354	-	-											
236 x 35.5	3	2	RST.600.90.3.WPV	\$10,418	\$12,755	\$12,072	\$14,527	\$14,324	\$16,692	-	-											
236 x 47	3	2	RST.600.120.3.WPV	\$11,879	\$14,237	\$13,943	\$16,100	\$14,810	\$17,394	\$13,943	\$16,100											
248 x 35.5	3	2	RST.630.90.3.WPV	\$14,301	\$16,663	\$16,489	\$18,865	\$17,979	\$20,486	\$16,489	\$18,865											
248 x 47	3	2	RST.630.120.3.WPV	\$12,746	\$15,110	\$14,614	\$16,971	\$15,853	\$18,215	\$14,614	\$16,971											



**Relic Bar Height Table with Power**  
height 41.5"

SIZE (Inch)	TOP PIECES	CUT-OUTS	ORDER CODE	PRICE						PRICE												
				Cutline Edge		Rustic		Fenix		Sawn Top												
				Standard	Vintage	RAL/Raw	Vintage	RAL/Raw	Vintage	RAL/Raw	Vintage	RAL/Raw	Vintage	RAL/Raw	Vintage							
			<b>Frame Finish:</b>																			
63 x 31.5	1	1	RSP.160.80.1.WPV	\$4,891	\$6,255	\$5,822	\$7,149	\$6,814	\$8,141	\$5,822	\$7,149											
63 x 35.5	1	1	RSP.160.90.1.WPV	\$4,926	\$6,290	\$5,934	\$7,222	\$6,882	\$8,240	\$5,934	\$7,222											
63 x 47	1	1	RSP.160.120.1.WPV	\$5,044	\$6,524	\$6,240	\$7,437	\$7,286	\$8,600	\$6,240	\$7,437											
71 x 31.5	1	1	RSP.180.80.1.WPV	\$4,967	\$6,331	\$6,025	\$7,348	\$7,135	\$8,464	\$6,025	\$7,348											
71 x 35.5	1	1	RSP.180.90.1.WPV	\$5,017	\$6,377	\$6,120	\$7,443	\$7,261	\$8,582	\$6,120	\$7,443											
71 x 47	1	1	RSP.180.120.1.WPV	\$5,100	\$6,613	\$6,375	\$7,571	\$7,658	\$8,762	\$6,375	\$7,571											
82.5 x 35.5	1	1	RSP.210.90.1.WPV	\$5,052	\$6,423	\$6,228	\$7,549	\$7,458	\$8,786	\$6,228	\$7,549											
82.5 x 47	1	1	RSP.210.120.1.WPV	\$5,120	\$6,491	\$6,263	\$7,586	\$7,468	\$8,795	\$6,263	\$7,586											
92.5 x 35.5	1	1	RSP.235.90.1.WPV	\$5,445	\$6,756	\$6,509	\$7,801	\$7,756	\$9,047	\$6,509	\$7,801											
92.5 x 47	1	1	RSP.235.120.1.WPV	\$5,228	\$6,623	\$6,348	\$7,677	\$7,725	\$8,805	\$6,348	\$7,677											
94.5 x 35.5	1	1	RSP.240.90.1.WPV	\$5,503	\$6,874	\$6,609	\$7,919	\$7,861	\$9,078	\$6,609	\$7,919											
94.5 x 47	1	1	RSP.240.120.1.WPV	-	-	-	-	-	-	\$6,491	\$7,799											
118 x 35.5	1	2	RSP.300.90.1.WPV	-	-	-	-	-	-	\$6,727	\$8,076											
118 x 47	1	2	RSP.300.120.1.WPV	\$6,556	\$8,024	\$7,753	\$9,061	\$8,993	\$10,121	-	-											
118 x 35.5	2	2	RSP.300.90.2.WPV	\$6,987	\$8,366	\$7,989	\$9,338	\$9,276	\$10,400	-	-											
118 x 47	2	2	RSP.300.120.2.WPV	\$7,620	\$8,299	-	-	\$9,179	\$10,353	-	-											
126 x 35.5	2	2	RSP.320.90.2.WPV	\$7,885	\$9,285	-	-	\$9,554	\$10,622	-	-											
126 x 47	2	2	RSP.320.120.2.WPV	\$9,879	\$12,141	\$11,081	\$14,248	\$14,284	\$16,287	\$11,081	\$13,093											
141.5 x 35.5	2	2	RSP.360.90.2.WPV	\$10,090	\$12,419	\$11,514	\$14,528	\$14,542	\$16,900	\$11,514	\$13,360											
141.5 x 47	2	2	RSP.360.120.2.WPV	\$9,937	\$12,338	\$11,398	\$14,389	\$14,327	\$16,853	\$11,398	\$13,265											
149.5 x 35.5	2	2	RSP.380.90.2.WPV	\$10,307	\$12,619	\$12,046	\$15,172	\$14,702	\$17,153	\$12,046	\$13,727											
149.5 x 47	2	2	RSP.380.120.2.WPV	\$10,253	\$12,510	\$11,951	\$15,062	\$14,689	\$17,142	\$11,951	\$13,675											
165.5 x 35.5	2	2	RSP.420.90.2.WPV																			



**Relic** Table with Castors  
height 29.5"

SIZE (Inch)	TOP PIECES	ORDER CODE	PRICE						PRICE							
			Cutline Edge						Sawn Top							
			Standard		Rustic		Fenix		RAL/Raw		Vintage		RAL/Raw		Vintage	
			Frame Finish:													
			RAL/Raw	Vintage	RAL/Raw	Vintage	RAL/Raw	Vintage	RAL/Raw	Vintage	RAL/Raw	Vintage	RAL/Raw	Vintage	RAL/Raw	Vintage
55 x 31.5	1	RSMT.140.80.1	\$4,043	\$5,478	\$5,039	\$6,364	\$6,030	\$7,355	\$5,039	\$6,364						
55 x 35.5	1	RSMT.140.90.1	\$4,066	\$5,503	\$5,182	\$6,415	\$6,051	\$7,417	\$5,182	\$6,415						
55 x 47	1	RSMT.140.120.1	\$4,178	\$5,631	\$5,542	\$6,767	\$6,411	\$7,800	\$5,542	\$6,767						
63 x 31.5	1	RSMT.160.80.1	\$4,126	\$5,558	\$5,235	\$6,560	\$6,351	\$7,676	\$5,235	\$6,560						
63 x 35.5	1	RSMT.160.90.1	\$4,186	\$5,592	\$5,463	\$6,633	\$6,498	\$7,850	\$5,463	\$6,633						
63 x 47	1	RSMT.160.120.1	\$4,300	\$5,718	\$5,730	\$6,848	\$6,850	\$8,053	\$5,730	\$6,848						
71 x 31.5	1	RSMT.180.80.1	\$4,215	\$5,645	\$5,442	\$6,767	\$6,678	\$7,997	\$5,442	\$6,767						
71 x 35.5	1	RSMT.180.90.1	\$4,279	\$5,714	\$5,480	\$6,805	\$6,740	\$8,009	\$5,480	\$6,805						
71 x 47	1	RSMT.180.120.1	\$4,530	\$5,941	\$5,859	\$7,111	\$6,960	\$8,268	\$5,859	\$7,111						
82.5 x 35.5	1	RSMT.210.90.1	\$4,480	\$5,828	\$5,589	\$6,734	\$6,925	\$8,090	\$5,589	\$6,734						
82.5 x 47	1	RSMT.210.120.1	\$4,666	\$6,099	\$5,962	\$7,248	\$7,047	\$8,307	\$5,964	\$7,248						
92.5 x 35.5	1	RSMT.235.90.1	-	-	-	-	-	-	\$5,685	\$6,999						
92.5 x 47	1	RSMT.235.120.1	-	-	-	-	-	-	\$6,107	\$7,372						
94.5 x 35.5	1	RSMT.240.90.1	\$4,627	\$6,018	\$5,685	\$6,999	\$6,933	\$8,136	-	-						
94.5 x 47	1	RSMT.240.120.1	\$4,888	\$6,326	\$6,107	\$7,372	\$7,212	\$8,367	-	-						
118 x 35.5	1	RSMT.300.90.1	\$5,517	\$6,246	-	-	\$7,107	\$8,312	-	-						
118 x 47	1	RSMT.300.120.1	\$5,786	\$7,245	-	-	\$7,484	\$8,568	-	-						



**Relic** Table with Castors and Power  
height 29.5"

SIZE (Inch)	TOP PIECES	CUT-OUTS	ORDER CODE	PRICE						PRICE							
				Cutline Edge						Sawn Top							
				Standard		Rustic		Fenix		RAL/Raw		Vintage		RAL/Raw		Vintage	
				Frame Finish:													
				RAL/Raw	Vintage	RAL/Raw	Vintage	RAL/Raw	Vintage	RAL/Raw	Vintage	RAL/Raw	Vintage	RAL/Raw	Vintage	RAL/Raw	Vintage
63 x 31.5	1	1	RSMT.160.80.1.WPV	\$5,305	\$6,740	\$6,301	\$7,626	\$7,292	\$8,617	\$6,301	\$7,626						
63 x 35.5	1	1	RSMT.160.90.1.WPV	\$5,328	\$6,765	\$6,444	\$7,677	\$7,313	\$8,679	\$6,444	\$7,677						
63 x 47	1	1	RSMT.160.120.1.WPV	\$5,440	\$6,893	\$6,804	\$8,029	\$7,673	\$9,062	\$6,804	\$8,029						
71 x 31.5	1	1	RSMT.180.80.1.WPV	\$5,388	\$6,820	\$6,497	\$7,822	\$7,613	\$8,938	\$6,497	\$7,822						
71 x 35.5	1	1	RSMT.180.90.1.WPV	\$5,448	\$6,854	\$6,725	\$7,895	\$7,760	\$9,112	\$6,725	\$7,895						
71 x 47	1	1	RSMT.180.120.1.WPV	\$5,562	\$6,980	\$6,992	\$8,110	\$8,112	\$9,315	\$6,992	\$8,110						
82.5 x 35.5	1	1	RSMT.210.90.1.WPV	\$5,477	\$6,907	\$6,704	\$8,029	\$7,940	\$9,259	\$6,704	\$8,029						
82.5 x 47	1	1	RSMT.210.120.1.WPV	\$5,541	\$6,976	\$6,742	\$8,067	\$8,002	\$9,271	\$6,742	\$8,067						
92.5 x 35.5	1	1	RSMT.235.90.1.WPV	-	-	-	-	-	-	\$7,121	\$8,373						
92.5 x 47	1	1	RSMT.235.120.1.WPV	-	-	-	-	-	-	\$6,851	\$7,996						
94.5 x 35.5	1	1	RSMT.240.90.1.WPV	\$5,889	\$7,280	\$6,947	\$8,261	\$8,195	\$9,398	-	-						
94.5 x 47	1	1	RSMT.240.120.1.WPV	\$6,150	\$7,588	\$7,369	\$8,634	\$8,474	\$9,629	-	-						
118 x 35.5	1	2	RSMT.300.90.1.WPV	\$8,041	\$8,770	-	-	\$9,631	\$10,836	-	-						
118 x 47	1	2	RSMT.300.120.1.WPV	\$8,310	\$9,769	-	-	\$10,008	\$11,092	-	-						

**PLEASE NOTE:** Power must be disconnected before moving the table.

Specify power module option - see page 66 for more information. Price includes cut-out/s in table top, power flap, cable tray and power modules.



**Relic** Bar Height Table with Castors  
height 41.5"

SIZE (Inch)	TOP PIECES	ORDER CODE	PRICE						PRICE							
			Cutline Edge						Sawn Top							
			Standard		Rustic		Fenix		RAL/Raw		Vintage		RAL/Raw		Vintage	
			Frame Finish:													
			RAL/Raw	Vintage	RAL/Raw	Vintage	RAL/Raw	Vintage	RAL/Raw	Vintage	RAL/Raw	Vintage	RAL/Raw	Vintage	RAL/Raw	Vintage
55 x 31.5	1	RSMP140.80.1	\$4,296	\$5,660	\$5,227	\$6,554	\$6,219	\$7,546	\$5,227	\$6,554						
55 x 35.5	1	RSMP140.90.1	\$4,331	\$5,695	\$5,339	\$6,627	\$6,287	\$7,645	\$5,339	\$6,627						
55 x 47	1	RSMP140.120.1	\$4,449	\$5,929	\$5,645	\$6,842	\$6,691	\$8,005	\$5,645	\$6,842						
63 x 31.5	1	RSMP160.80.1	\$4,372	\$5,736	\$5,430	\$6,753	\$6,540	\$7,869	\$5,430	\$6,753						
63 x 35.5	1	RSMP160.90.1	\$4,422	\$5,782	\$5,525	\$6,848	\$6,666	\$7,987	\$5,525	\$6,848						
63 x 47	1	RSMP160.120.1	\$4,505	\$6,018	\$5,780	\$6,976	\$7,063	\$8,167	\$5,780	\$6,976						
71 x 31.5	1	RSMP180.80.1	\$4,457	\$5,828	\$5,633	\$6,954	\$6,863	\$8,191	\$5,633	\$6,954						
71 x 35.5	1	RSMP180.90.1	\$4,525	\$5,896	\$5,668	\$6,991	\$6,873	\$8,200	\$5,668	\$6,991						
71 x 47	1	RSMP180.120.1	\$4,850	\$6,161	\$5,914	\$7,206	\$7,161	\$8,452	\$5,914	\$7,206						
82.5 x 35.5	1	RSMP210.90.1	\$4,633	\$6,028	\$5,753	\$7,082	\$7,130	\$8,210	\$5,753	\$7,082						
82.5 x 47	1	RSMP210.120.1	\$4,908	\$6,279	\$6,014	\$7,324	\$7,266	\$8,483	\$6,014	\$7,324						
92.5 x 35.5	1	RSMP235.90.1	-	-	-	-	-	-	\$5,896	\$7,204						
92.5 x 47	1	RSMP235.120.1	-	-	-	-	-	-	\$6,132	\$7,481						
94.5 x 35.5	1	RSMP240.90.1	\$4,699	\$6,167	\$5,896	\$7,204	\$7,136	\$8,264	-	-						
94.5 x 47	1	RSMP240.120.1	\$5,130	\$6,509	\$6,132	\$7,481	\$7,419	\$8,543	-	-						
118 x 35.5	1	RSMP300.90.1	\$5,763	\$6,442	-	-	\$7,322	\$8,496	-	-						
118 x 47	1	RSMP300.120.1	\$6,028	\$7,428	-	-	\$7,697	\$8,765	-	-						



**Relic** Bar Height Table with Castors and Power  
height 41.5"

SIZE (Inch)	TOP PIECES	CUT-OUTS	ORDER CODE	PRICE						PRICE							
				Cutline Edge						Sawn Top							
				Standard		Rustic		Fenix		RAL/Raw		Vintage		RAL/Raw		Vintage	
				Frame Finish:													
				RAL/Raw	Vintage	RAL/Raw	Vintage	RAL/Raw	Vintage	RAL/Raw	Vintage	RAL/Raw	Vintage	RAL/Raw	Vintage	RAL/Raw	Vintage
63 x 31.5	1	1	RSMP160.80.1.WPV	\$5,558	\$6,922	\$6,489	\$7,816	\$7,481	\$8,808	\$6,489	\$7,816						
63 x 35.5	1	1	RSMP160.90.1.WPV	\$5,593	\$6,957	\$6,601	\$7,889	\$7,549	\$8,907	\$6,601	\$7,889						
63 x 47	1	1	RSMP160.120.1.WPV	\$5,711	\$7,191	\$6,907	\$8,104	\$7,953	\$9,267	\$6,907	\$8,104						
71 x 31.5	1	1	RSMP180.80.1.WPV	\$5,634	\$6,998	\$6,692	\$7,802	\$7,802	\$9,131	\$6,692	\$7,802						
71 x 35.5	1	1	RSMP180.90.1.WPV	\$5,684	\$7,044	\$6,787	\$7,810	\$7,928	\$9,249	\$6,787	\$7,810						
71 x 47	1	1	RSMP180.120.1.WPV	\$5,767	\$7,280	\$7,042	\$8,238	\$8,325	\$9,429	\$7,042	\$8,238						
82.5 x 35.5	1	1	RSMP210.90.1.WPV	\$5,719	\$7,090	\$6,895	\$8,216	\$8,125	\$9,453	\$6,895	\$8,216						
82.5 x 47	1	1	RSMP210.120.1.WPV	\$5,787	\$7,158	\$6,930	\$8,253	\$8,135	\$9,462	\$6,930	\$8,253						
92.5 x 35.5	1	1	RSMP235.90.1.WPV	-	-	-	-	-	-	\$7,176	\$8,468						
92.5 x 47	1	1	RSMP235.120.1.WPV	-	-	-	-	-	-	\$7,015	\$8,344						
94.5 x 35.5	1	1	RSMP240.90.1.WPV	\$5,961	\$7,429	\$7,158	\$8,466	\$8,398	\$9,526	-	-						
94.5 x 47	1	1	RSMP240.120.1.WPV	\$6,392	\$7,771	\$7,394	\$8,743	\$8,681	\$9,805	-	-						
118 x 35.5	1	2	RSMP300.90.1.WPV	\$8,287	\$8,966	-	-	\$9,846	\$11,020	-	-						
118 x 47	1	2	RSMP300.120.1.WPV	\$8,552	\$9,952	-	-	\$10,221	\$11,289	-	-						

**PLEASE NOTE:** Power must be disconnected before moving the table.

Shroud and power flap in a contrasting finish to framework RAL/Raw: + \$203 Vintage: + \$406 Custom cut-out + \$185



**Relic Wide Table**  
height 29.5"

SIZE (Inch)	TOP PIECES	ORDER CODE	PRICE						PRICE	
			Cutline Edge		Rustic		Fenix		Sawn Top	
		Frame Finish:	RAL/Raw	Vintage	RAL/Raw	Vintage	RAL/Raw	Vintage	RAL/Raw	Vintage
92.5 x 63	2	RSW.235.160	\$7,335	\$8,299	\$8,057	\$9,018	\$10,944	\$11,906	\$8,057	\$9,018
122 x 63	4	RSW.310.160	\$14,520	\$16,363	\$16,496	\$18,338	\$18,477	\$20,322	\$16,496	\$18,338
141.5 x 63	4	RSW.360.160	\$15,282	\$17,222	\$17,364	\$19,306	\$19,450	\$21,390	\$17,364	\$19,306



**Relic Low Stool (upholstered)**  
width 16, depth 15.5, height 18"

FABRIC	ORDER CODE	PRICE	
		Upholstered	
	Frame Finish:	RAL/Raw	Vintage
1	RSS.U.LHT.40D.FBB	\$1,226	\$1,734
2	RSS.U.LHT.40D.FBC	\$1,251	\$1,755
3	RSS.U.LHT.40D.FBD	\$1,279	\$1,780
4	RSS.U.LHT.40D.FBE	\$1,323	\$1,819
5	RSS.U.LHT.40D.FBF	\$1,357	\$1,858
6	RSS.U.LHT.40D.FBG	\$1,435	\$1,934
7	RSS.U.LHT.40D.FBH	\$1,511	\$2,013
8	RSS.U.LHT.40D.FBI	\$1,589	\$2,088



**Relic High Stool (upholstered)**  
width 16, depth 15.5, height 30"

FABRIC	ORDER CODE	PRICE	
		Upholstered	
	Frame Finish:	RAL/Raw	Vintage
1	RSS.U.HHT.40D.FBB	\$1,329	\$1,934
2	RSS.U.HHT.40D.FBC	\$1,355	\$1,964
3	RSS.U.HHT.40D.FBD	\$1,380	\$1,983
4	RSS.U.HHT.40D.FBE	\$1,424	\$2,022
5	RSS.U.HHT.40D.FBF	\$1,458	\$2,068
6	RSS.U.HHT.40D.FBG	\$1,539	\$2,141
7	RSS.U.HHT.40D.FBH	\$1,610	\$2,220
8	RSS.U.HHT.40D.FBI	\$1,691	\$2,295



**Relic Wide Table with Power**  
height 29.5"

SIZE (Inch)	TOP PIECES	CUT-OUTS	ORDER CODE	PRICE						PRICE	
				Cutline Edge		Rustic		Fenix		Sawn Top	
			Frame Finish:	RAL/Raw	Vintage	RAL/Raw	Vintage	RAL/Raw	Vintage	RAL/Raw	Vintage
92.5 x 63	2	1	RSW.235.160.WPV	\$8,597	\$9,561	\$9,319	\$10,280	\$12,206	\$13,168	\$9,319	\$10,280
122 x 63	4	2	RSW.310.160.WPV	\$17,044	\$18,887	\$19,020	\$20,862	\$21,001	\$22,846	\$19,020	\$20,862
141.5 x 63	4	2	RSW.360.160.WPV	\$17,806	\$19,746	\$19,888	\$21,830	\$21,974	\$23,914	\$19,888	\$21,830



**Relic Small Bench (upholstered)**  
width 39.5, depth 15.5, height 18"

FABRIC	ORDER CODE	PRICE	
		Upholstered	
	Frame Finish:	RAL/Raw	Vintage
1	RSB.U.104R.FBB	\$2,378	\$2,893
2	RSB.U.104R.FBC	\$2,429	\$2,944
3	RSB.U.104R.FBD	\$2,479	\$2,997
4	RSB.U.104R.FBE	\$2,562	\$3,073
5	RSB.U.104R.FBF	\$2,638	\$3,156
6	RSB.U.104R.FBG	\$2,795	\$3,303
7	RSB.U.104R.FBH	\$2,944	\$3,462
8	RSB.U.104R.FBI	\$3,100	\$3,613



**Relic Medium Bench (upholstered)**  
width 63, depth 15.5, height 18"

FABRIC	ORDER CODE	PRICE	
		Upholstered	
	Frame Finish:	RAL/Raw	Vintage
1	RSB.U.164R.FBB	\$2,744	\$3,264
2	RSB.U.164R.FBC	\$2,852	\$3,365
3	RSB.U.164R.FBD	\$2,956	\$3,471
4	RSB.U.164R.FBE	\$3,107	\$3,623
5	RSB.U.164R.FBF	\$3,264	\$3,779
6	RSB.U.164R.FBG	\$3,574	\$4,085
7	RSB.U.164R.FBH	\$3,885	\$4,395
8	RSB.U.164R.FBI	\$4,193	\$4,706

Specify power module option - see page 66 for more information. Price includes cut-out/s in table top, power flap, cable tray and power modules.

Shroud and power flap in a contrasting finish to framework	RAL/Raw: + \$203	Vintage: + \$406	Custom cut-out	+ \$185
--	------------------	------------------	----------------	---------



## RELIC ROUND/SQUARE - STEPS TO SPECIFY

Follow our guide and customize our products to suit your space

- 1 2 3 4 5

Select Height: Standard or Bar height

- 1 2 3 4 5

Select Size

- 1 2 3 4 5

Select Power: Powered or Non-powered

Tables with Power have concealed integrated cable management.



**Solo Power Unit**  
1x Power Outlet & 1x Twin USB Charge.  
(1x Type-C & 1x Type-A)  
Available in Black or White

- 1 2 3 4 5

Select Frame Finish: RAL, Vintage or Raw Steel

RAL metal frame finishes

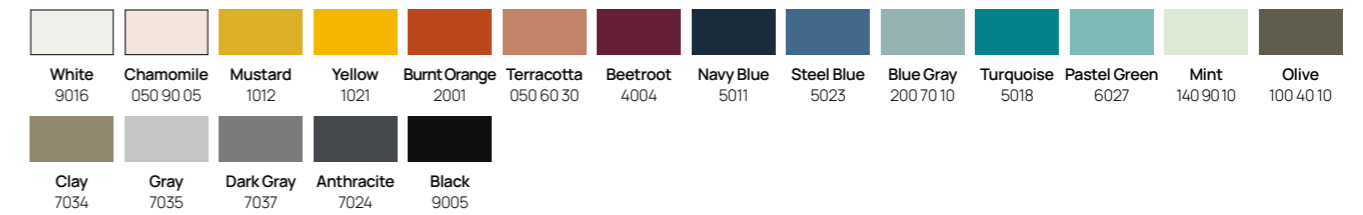

Vintage metal frame finishes

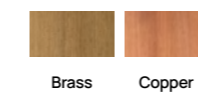

Metal frame finishes

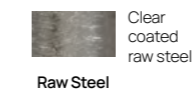

- 1 2 3 4 5

Select Top Type and Finish: Cutline edge laminate or Sawn Oak



Cutline edge  
top thickness 1"

Cutline Standard Laminate



Cutline Fenix



Cutline Rustic

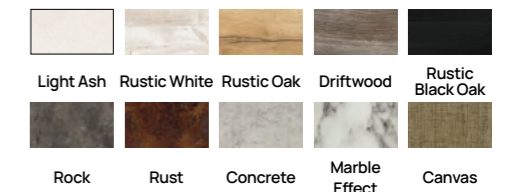

Sawn edge  
top thickness 1.1"

Sawn Oak

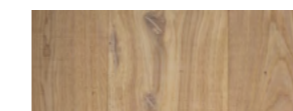

Sawn Weathered Oak





**Relic 3 Leg Round Table**  
height 29"

SIZE (Inch)	ORDER CODE	PRICE				PRICE			
	Cutline Edge	Standard		Rustic		Fenix		Sawn Top	
	Frame Finish:	RAL/Raw	Vintage	RAL/Raw	Vintage	RAL/Raw	Vintage	RAL/Raw	Vintage
35.5 dia	RET.90D	\$2,849	\$3,555	\$3,610	\$4,370	\$4,366	\$5,172	\$3,610	\$4,370
39.5 dia	RET.100D	\$2,921	\$3,629	\$3,686	\$4,442	\$4,409	\$5,227	\$3,686	\$4,442



**Relic 4 Leg Round Table**  
height 29"

SIZE (Inch)	ORDER CODE	PRICE				PRICE			
	Cutline Edge	Standard		Rustic		Fenix		Sawn Top	
	Frame Finish:	RAL/Raw	Vintage	RAL/Raw	Vintage	RAL/Raw	Vintage	RAL/Raw	Vintage
47 dia	RET.120D	\$3,662	\$4,501	\$4,342	\$5,222	\$5,008	\$5,939	\$4,342	\$5,222
55 dia	RET.140D	-	-	-	-	-	-	\$4,798	\$5,738



**Relic 3 Leg Round Table with Power**  
height 29"

SIZE (Inch)	ORDER CODE	PRICE				PRICE			
	Cutline Edge	Standard		Rustic		Fenix		Sawn Top	
	Frame Finish:	RAL/Raw	Vintage	RAL/Raw	Vintage	RAL/Raw	Vintage	RAL/Raw	Vintage
35.5 dia	RET.90D.SP1	\$3,483	\$4,189	\$4,244	\$5,004	\$5,000	\$5,806	\$4,244	\$5,004
39.5 dia	RET.100D.SP1	\$3,555	\$4,263	\$4,320	\$5,076	\$5,043	\$5,861	\$4,320	\$5,076



**Relic 4 Leg Round Table with Power**  
height 29"

SIZE (Inch)	ORDER CODE	PRICE				PRICE			
	Cutline Edge	Standard		Rustic		Fenix		Sawn Top	
	Frame Finish:	RAL/Raw	Vintage	RAL/Raw	Vintage	RAL/Raw	Vintage	RAL/Raw	Vintage
47 dia	RET.120D.SP1	\$4,296	\$5,135	\$4,976	\$5,856	\$5,642	\$6,573	\$4,976	\$5,856
55 dia	RET.140D.SP1	-	-	-	-	-	-	\$5,432	\$6,372



**Relic 3 Leg Round Bar Height Table**  
height 41.5"

SIZE (Inch)	ORDER CODE	PRICE				PRICE			
	Cutline Edge	Standard		Rustic		Fenix		Sawn Top	
	Frame Finish:	RAL/Raw	Vintage	RAL/Raw	Vintage	RAL/Raw	Vintage	RAL/Raw	Vintage
35.5 dia	REP.90D	\$3,063	\$3,787	\$3,861	\$4,621	\$4,599	\$5,412	\$3,861	\$4,621
39.5 dia	REP.100D	\$3,133	\$3,865	\$3,931	\$4,698	\$4,645	\$5,463	\$3,931	\$4,698



**Relic 4 Leg Round Bar Height Table**  
height 41.5"

SIZE (Inch)	ORDER CODE	PRICE				PRICE			
	Cutline Edge	Standard		Rustic		Fenix		Sawn Top	
	Frame Finish:	RAL/Raw	Vintage	RAL/Raw	Vintage	RAL/Raw	Vintage	RAL/Raw	Vintage
47 dia	REP.120D	\$3,950	\$4,809	\$4,613	\$5,493	\$5,261	\$6,194	\$4,613	\$5,493
55 dia	REP.140D	-	-	-	-	-	-	\$5,065	\$6,002



**Relic 3 Leg Round Bar Height Table with Power**  
height 41.5"

SIZE (Inch)	ORDER CODE	PRICE				PRICE			
	Cutline Edge	Standard		Rustic		Fenix		Sawn Top	
	Frame Finish:	RAL/Raw	Vintage	RAL/Raw	Vintage	RAL/Raw	Vintage	RAL/Raw	Vintage
35.5 dia	REP.90D.SP1	\$3,697	\$4,421	\$4,495	\$5,255	\$5,233	\$6,046	\$4,495	\$5,255
39.5 dia	REP.100D.SP1	\$3,767	\$4,499	\$4,565	\$5,332	\$5,279	\$6,097	\$4,565	\$5,332



**Relic 4 Leg Round Bar Height Table with Power**  
height 41.5"

SIZE (Inch)	ORDER CODE	PRICE				PRICE			
	Cutline Edge	Standard		Rustic		Fenix		Sawn Top	
	Frame Finish:	RAL/Raw	Vintage	RAL/Raw	Vintage	RAL/Raw	Vintage	RAL/Raw	Vintage
47 dia	REP.120D.SP1	\$4,584	\$5,443	\$5,247	\$6,127	\$5,895	\$6,828	\$5,247	\$6,127
55 dia	REP.140D.SP1	-	-	-	-	-	-	\$5,699	\$6,636

**Note:** Relic 4 and 3 Leg Tables with Power have concealed integrated cable management in one leg.





**Relic 4 Leg Square Table**  
height 41.5"

SIZE (Inch)	ORDER CODE	PRICE				PRICE			
	Cutline Edge	Standard		Rustic		Fenix		Sawn Top	
	Frame Finish:	RAL/Raw	Vintage	RAL/Raw	Vintage	RAL/Raw	Vintage	RAL/Raw	Vintage
39.5 x 39.5	RET100S	\$3,592	\$4,420	\$4,368	\$5,143	\$5,174	\$6,004	\$4,368	\$5,143
47 x 47	RET120S	\$3,802	\$4,647	\$4,934	\$5,744	\$6,061	\$6,940	\$4,934	\$5,744



**Relic 4 Leg Square Table with Power**  
height 41.5"

SIZE (Inch)	ORDER CODE	PRICE				PRICE			
	Cutline Edge	Standard		Rustic		Fenix		Sawn Top	
	Frame Finish:	RAL/Raw	Vintage	RAL/Raw	Vintage	RAL/Raw	Vintage	RAL/Raw	Vintage
39.5 x 39.5	RET100S.SP1	\$4,226	\$5,054	\$5,002	\$5,777	\$5,808	\$6,638	\$5,002	\$5,777
47 x 47	RET120S.SP1	\$4,436	\$5,281	\$5,568	\$6,378	\$6,695	\$7,574	\$5,568	\$6,378



**Relic 4 Leg Square Bar Height Table**  
height 41.5"

SIZE (Inch)	ORDER CODE	PRICE				PRICE			
	Cutline Edge	Standard		Rustic		Fenix		Sawn Top	
	Frame Finish:	RAL/Raw	Vintage	RAL/Raw	Vintage	RAL/Raw	Vintage	RAL/Raw	Vintage
39.5 x 39.5	REP100S	\$3,883	\$4,733	\$4,698	\$5,583	\$5,489	\$6,439	\$4,698	\$5,583
47 x 47	REP120S	\$4,088	\$4,956	\$5,222	\$6,151	\$6,330	\$7,342	\$5,222	\$6,151



**Relic 4 Leg Square Bar Height Table with Power**  
height 41.5"

SIZE (Inch)	ORDER CODE	PRICE				PRICE			
	Cutline Edge	Standard		Rustic		Fenix		Sawn Top	
	Frame Finish:	RAL/Raw	Vintage	RAL/Raw	Vintage	RAL/Raw	Vintage	RAL/Raw	Vintage
39.5 x 39.5	REP100S.SP1	\$4,517	\$5,367	\$5,332	\$6,217	\$6,123	\$7,073	\$5,332	\$6,217
47 x 47	REP120S.SP1	\$4,722	\$5,590	\$5,856	\$6,785	\$6,964	\$7,976	\$5,856	\$6,785

**Note:** Relic 4 and 3 Leg Tables with Power have concealed integrated cable management in one leg.



# RELIC CLOUD

---

An original bold design that creates a statement centerpiece for any environment. Relic Cloud has been designed as a canvas to enable you to incorporate both biophilia and lighting options.



## FEATURES

---

Fully integrated cable management

Power and data options

Mobile versions available in specific sizes

Mesh hanging trays allow multiple fixing points

Quick Ship available on selected variations and finishes, see pages 12 - 17 for more information.

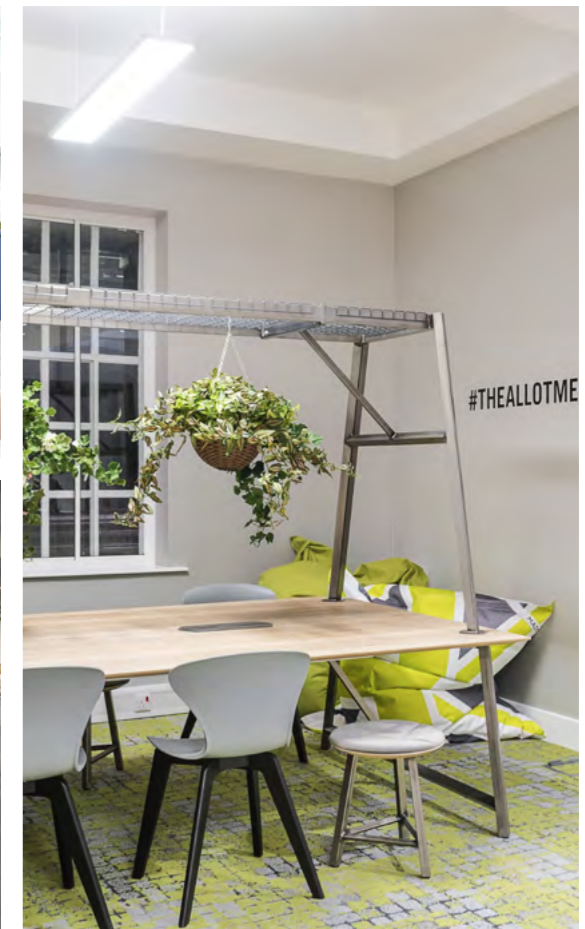

STEPS TO SPECIFY

Follow our guide and customize our products to suit your space

- 1
- 2
- 3
- 4
- 5
- 6

Select Format: With or without castors (92.5 x 62.9" size only)

- 1
- 2
- 3
- 4
- 5
- 6

Select Size

- 1
- 2
- 3
- 4
- 5
- 6

Select Power: Powered or Non-powered

Relic Cloud can be specified with or without integrated power. Tables with Power are supplied with one or more steel lift-out power flaps that match the selected frame color. The cable tray and power modules are White as standard but are available in Black on request.

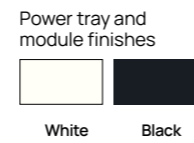

Standard power configuration for Relic Cloud with Power

For power variations, the amount of power cut-outs per table varies depending on the length. Power modules per power cut-out are available with one of the options below.

Table Width	Power Cut-outs
92.5"	1
122 / 141.7"	2

Option A

Includes: 4x Power Outlets & 2x Twin USB Charge (1x Type-C & 1x Type-A USB Charge)



Option B

Includes: 4x Power Outlets & 1x Twin USB Charge (1x Type-C & 1x Type-A USB Charge) & 1x HDMI



Option C (-\$1,262 from RRP)

No power modules. Cable tray only for customers own power.



- 1
- 2
- 3
- 4
- 5
- 6

Select Frame Finish: RAL or Raw Steel

RAL metal frame finishes

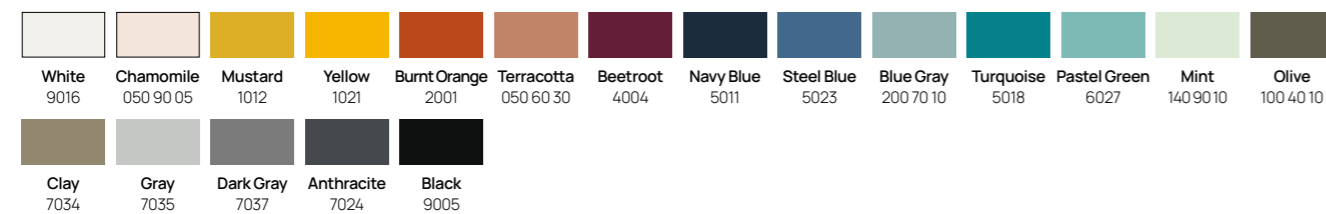

Metal frame finishes



- 1
- 2
- 3
- 4
- 5
- 6

Select Top Type and Finish: Outline edge laminate or Sawn Oak



Outline Standard Laminate

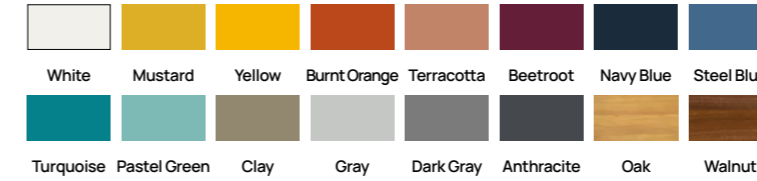

Outline Fenix



Outline Rustic

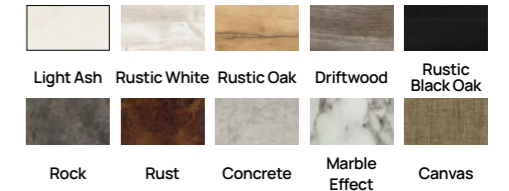

Sawn Oak

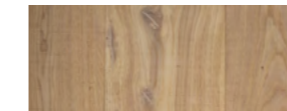

Sawn Weathered Oak



- 1
- 2
- 3
- 4
- 5
- 6

Select Accessories:

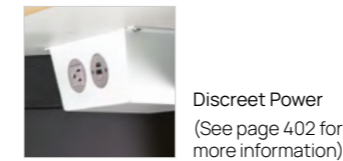



**Relic Cloud**

height 78.5, table top height 29.5"

SIZE (Inch)	TOP PIECES	ORDER CODE	PRICE			PRICE
			Standard	Rustic	Fenix	Sawn Top
		<b>Cutline Edge</b>				
		<b>RAL/Raw</b>				
92.5 x 63	2	RSO.235.160	\$11,943	\$12,643	\$15,425	\$12,643
122 x 63	4	RSO.310.160	\$17,712	\$19,108	\$19,108	\$19,108
141.5 x 63	4	RSO.360.160	\$20,246	\$22,246	\$24,249	\$22,246



**Relic Cloud with Power**

height 78.5, table top height 29.5"

SIZE (Inch)	TOP PIECES	CUT-OUTS	ORDER CODE	PRICE			PRICE
				Standard	Rustic	Fenix	Sawn Top
			<b>Cutline Edge</b>				
			<b>RAL/Raw</b>				
92.5 x 63	2	1	RSO.235.160.WPV	\$13,205	\$13,905	\$16,687	\$13,905
122 x 63	4	2	RSO.310.160.WPV	\$20,236	\$21,632	\$21,632	\$21,632
141.5 x 63	4	2	RSO.360.160.WPV	\$22,770	\$24,770	\$26,773	\$24,770



**Relic Cloud on Castors**

height 78.5, table top height 29.5"

SIZE (Inch)	TOP PIECES	ORDER CODE	PRICE			PRICE
			Standard	Rustic	Fenix	Sawn Top
		<b>Cutline Edge</b>				
		<b>RAL/Raw</b>				
92.5 x 63	2	RSMO.235.160	\$12,610	\$13,310	\$16,092	\$13,310



**Relic Cloud on Castors with Power**

height 78.5, table top height 29.5"

SIZE (Inch)	TOP PIECES	CUT-OUTS	ORDER CODE	PRICE			PRICE
				Standard	Rustic	Fenix	Sawn Top
			<b>Cutline Edge</b>				
			<b>RAL/Raw</b>				
92.5 x 63	2	1	RSMO.235.160.WPV	\$13,872	\$14,572	\$17,354	\$14,572

**PLEASE NOTE: Power must be disconnected before moving the table.**

Specify power module option - see page 86 for more information. Price includes cut-out/s in table top, power flap, cable tray and power modules.

Shroud and power flap in a contrasting finish to framework	RAL/Raw: +\$203	Custom cut-out	+\$185
--	-----------------	----------------	--------



# JIG SOCIAL

---

A timeless range of tables available in a wide range of sizes and finishes. Handcrafted from solid oak, Jig Social is a warm and inviting place to meet. Practical for hot desking and collaboration.



## FEATURES

---

- Hand crafted solid oak frame
- Integrated cable management in all table legs
- Available in a range of shapes, heights and sizes
- Optional power and data ports
- Inset central leg on tables over 3m to allow uninterrupted seating
- Wide range of top colors and finishes



STEPS TO SPECIFY

Follow our guide and customize our products to suit your space

- 1
- 2
- 3
- 4
- 5
- 6
- 7

Select Height: Standard or Bar height

- 1
- 2
- 3
- 4
- 5
- 6
- 7

Select Frame Finish: Natural or Black Oak

Wood frame finishes



Natural Oak Black Oak

- 1
- 2
- 3
- 4
- 5
- 6
- 7

Select Size:  
Example sizes with chair configurations below, see page 92 for full range of sizes.

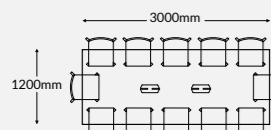
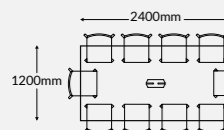
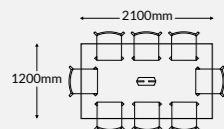
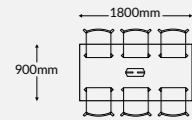

Diagrams show a 19.6" chair placed around the tables as seating capacity indication only. Capacity can be increased with the use of benches. Tables over 118.1" are more than one-piece tops, seams as shown below.

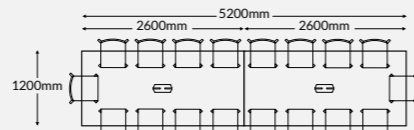
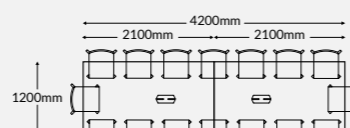
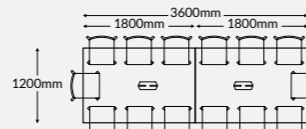
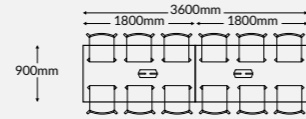

- 1
- 2
- 3
- 4
- 5
- 6
- 7

Select Power: Powered or Non-powered

Jig Social Tables can be specified with or without integrated power. Tables with Power are supplied with one or more steel lift-out power flaps that match the selected frame color. The cable tray and power modules are White as standard but are available in Black on request.

Power tray and module finishes



White Black

Standard power configuration for Jig Social Tables with Power

For power variations, the amount of power cut-outs per table varies depending on the length. Power modules per power cut-out are available with one of the options below.

Table Length	Power Cut-outs
62.9 to 94.4"	1
118.1" to 248"	2*

**Option A**  
Includes: 4x Power Outlets & 2x Twin USB Charge (1x Type-C & 1x Type-A USB Charge)



**Option B**  
Includes: 4x Power Outlets & 1x Twin USB Charge (1x Type-C & 1x Type-A USB Charge) & 1x HDMI



**Option C** (-\$1,262 from RRP)  
No power modules. Cable tray only for customers own power.



- 1
- 2
- 3
- 4
- 5
- 6
- 7

Select Lift-out Power Flap Finish: RAL or Raw Steel

RAL metal frame finishes

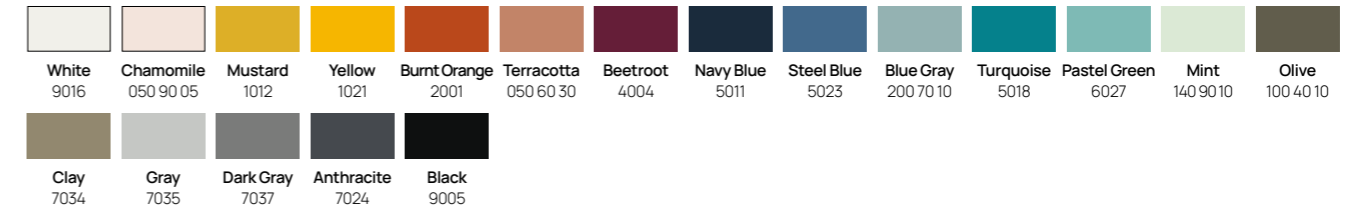

Metal frame finishes



- 1
- 2
- 3
- 4
- 5
- 6
- 7

Select Top Type and Finish: Cutline edge laminate



Cutline Standard Laminate



Cutline Fenix



Cutline Rustic

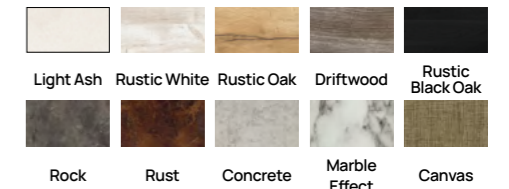

- 1
- 2
- 3
- 4
- 5
- 6
- 7

Select Accessories:

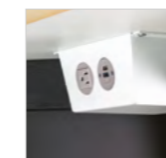

**Discreet Power**  
(See page 402 for more information)



Integrated cable management and levelling feet



Lift-out power flap





**Jig Social Table**  
height 29, top thickness 1"

SIZE (Inch)	TOP PIECES	ORDER CODE		PRICE		
		Cutline Edge		Standard	Rustic	Fenix
		Natural Oak Frame	Black Oak Frame			
71 x 35.5	1	JST.NOK.180.90.1	JST.BOK.180.90.1	\$4,852	\$5,737	\$6,624
82.5 x 47	1	JST.NOK.210.120.1	JST.BOK.210.120.1	\$5,316	\$6,019	\$6,725
94.5 x 47	1	JST.NOK.240.120.1	JST.BOK.240.120.1	\$5,378	\$6,074	\$6,771
118 x 47	1	JST.NOK.300.120.1	JST.BOK.300.120.1	\$6,534	-	\$7,410
141.5 x 47	2	JST.NOK.360.120.2	JST.BOK.360.120.2	\$10,746	\$12,155	\$13,564
165.5 x 47	2	JST.NOK.420.120.2	JST.BOK.420.120.2	\$11,986	\$12,898	\$13,811
204.5 x 47	2	JST.NOK.520.120.2	JST.BOK.520.120.2	\$13,047	\$13,859	\$14,674
236 x 47	3	JST.NOK.600.120.3	JST.BOK.600.120.3	\$16,790	\$17,206	\$17,620



**Jig Social Table with Power**  
height 29, top thickness 1"

SIZE (Inch)	TOP PIECES	CUT-OUTS	ORDER CODE		PRICE		
			Cutline Edge		Standard	Rustic	Fenix
			Natural Oak Frame	Black Oak Frame			
71 x 35.5	1	1	JST.NOK.180.90.1.WPV	JST.BOK.180.90.1.WPV	\$6,114	\$6,999	\$7,886
82.5 x 47	1	1	JST.NOK.210.120.1.WPV	JST.BOK.210.120.1.WPV	\$6,578	\$7,281	\$7,987
94.5 x 47	1	1	JST.NOK.240.120.1.WPV	JST.BOK.240.120.1.WPV	\$6,640	\$7,336	\$8,033
118 x 47	1	2	JST.NOK.300.120.1.WPV	JST.BOK.300.120.1.WPV	\$9,058	-	\$9,934
141.5 x 47	2	2	JST.NOK.360.120.2.WPV	JST.BOK.360.120.2.WPV	\$13,270	\$14,679	\$16,088
165.5 x 47	2	2	JST.NOK.420.120.2.WPV	JST.BOK.420.120.2.WPV	\$14,510	\$15,422	\$16,335
204.5 x 47	2	2	JST.NOK.520.120.2.WPV	JST.BOK.520.120.2.WPV	\$15,571	\$16,383	\$17,198
236 x 47	3	2	JST.NOK.600.120.3.WPV	JST.BOK.600.120.3.WPV	\$19,314	\$19,730	\$20,144



**Jig Social Bar Height Table**  
height 29, top thickness 1"

SIZE (Inch)	TOP PIECES	ORDER CODE		PRICE		
		Cutline Edge		Standard	Rustic	Fenix
		Natural Oak Frame	Black Oak Frame			
71 x 35.5	1	JSP.NOK.180.90.1	JSP.BOK.180.90.1	\$5,641	\$6,526	\$7,410
82.5 x 47	1	JSP.NOK.210.120.1	JSP.BOK.210.120.1	\$6,103	\$6,810	\$7,515
94.5 x 47	1	JSP.NOK.240.120.1	JSP.BOK.240.120.1	\$6,560	\$7,366	\$7,954
118 x 47	2	JSP.NOK.360.120.2	JSP.BOK.360.120.2	\$11,881	\$13,252	\$14,617
141.5 x 47	2	JSP.NOK.420.120.2	JSP.BOK.420.120.2	\$13,119	\$14,036	\$14,946



**Jig Social Bar Height Table with Power**  
height 29, top thickness 1"

SIZE (Inch)	TOP PIECES	CUT-OUTS	ORDER CODE		PRICE		
			Cutline Edge		Standard	Rustic	Fenix
			Natural Oak Frame	Black Oak Frame			
71 x 35.5	1	1	JSP.NOK.180.90.1.WPV	JSP.BOK.180.90.1.WPV	\$6,903	\$7,788	\$8,672
82.5 x 47	1	1	JSP.NOK.210.120.1.WPV	JSP.BOK.210.120.1.WPV	\$7,365	\$8,072	\$8,777
94.5 x 47	1	1	JSP.NOK.240.120.1.WPV	JSP.BOK.240.120.1.WPV	\$7,822	\$8,628	\$9,216
118 x 47	2	2	JSP.NOK.360.120.2.WPV	JSP.BOK.360.120.2.WPV	\$14,405	\$15,776	\$17,141
141.5 x 47	2	2	JSP.NOK.420.120.2.WPV	JSP.BOK.420.120.2.WPV	\$15,643	\$16,560	\$17,470

Specify power module option - see page 92 for more information. Price includes cut-out/s in table top, power flap, cable tray and power modules.

Custom cut-out + \$185



# SLENDTA TABLE

---

A sleek simplistic table with tapered steel legs available with optional integrated power. This versatile design comes in a range of sizes and finishes, offering elegance and practicality, suitable for any location.



## FEATURES

---

- Two options of power - leg or surface mounted
- Integrated cable management
- Available in a range of frame and top finishes



STEPS TO SPECIFY

Follow our guide and customize our products to suit your space

- 1
- 2
- 3
- 4
- 5

Select Size

- 1
- 2
- 3
- 4
- 5

Select Power: Non-powered, power in leg or power in table top

Slenda Tables can be specified with or without integrated power. Power in Leg Tables are supplied with power in 2x left-end legs, on opposite corners. Power in Table Top are supplied with one steel lift-out power flap that matches the selected frame color.



Black Power modules in two legs  
1x Power Outlet &  
1x Twin USB Charge  
(1x Type-A & 1x Type-C)

Power tray and module finishes



Table Top Power Module Options

<p><b>Option A</b> 4x Power Outlet &amp; 2x Twin USB Charge (1x Type-C &amp; 1x Type-A USB Charge)</p>	<p><b>Option B</b> 4x Power Outlet, 1x Twin USB Charge (1x Type-C &amp; 1x Type-A), 1x CAT6 &amp; 1x HDMI</p>	<p><b>Option C</b> 4x Power Outlet, 1x Twin USB Charge (1x Type-C &amp; 1x Type-A) &amp; 2x CAT6</p>	<p><b>Option D</b> (-\$1,262 from RRP) No power modules. Cable tray only for customers own power.</p>
--	---	--	---

- 1
- 2
- 3
- 4
- 5

Select Frame Finish: RAL colored or Raw Steel

RAL metal frame finishes

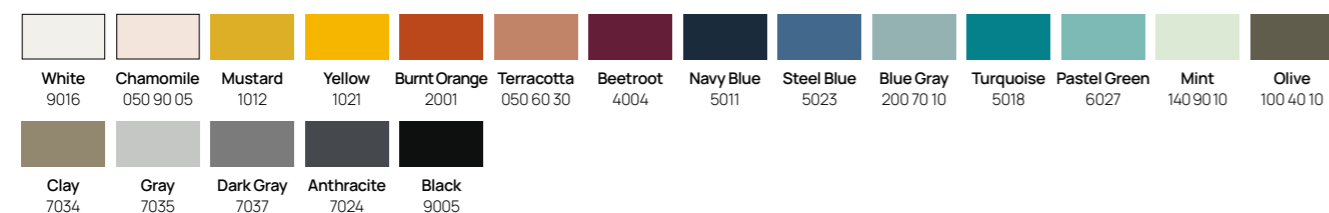

Metal frame finishes



- 1
- 2
- 3
- 4
- 5

Select Top Type and Finish:



Cutline Standard Laminate



Cutline Fenix



Cutline Rustic

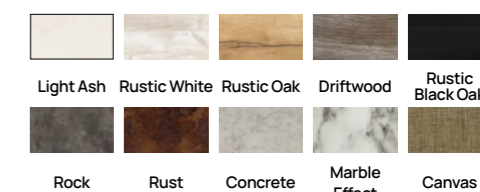

- 1
- 2
- 3
- 4
- 5

Select Accessories

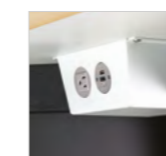

Discreet Power  
(See page 402 for more information)



**Slenda Table**  
height 29"

SIZE (Inch)	ORDER CODE	PRICE		
		Standard	Rustic	Fenix
	<b>Cutline Edge</b>			
	RAL/Raw			
71 x 31.5	STL.180.80	\$4,178	\$5,138	\$6,176
71 x 39.5	STL.180.100	\$4,377	\$5,263	\$6,231
71 x 47	STL.180.120	\$4,635	\$5,423	\$6,299
82.5 x 31.5	STL.210.80	\$4,455	\$5,302	\$6,244
82.5 x 39.5	STL.210.100	\$4,647	\$5,423	\$6,287
82.5 x 47	STL.210.120	\$4,909	\$5,580	\$6,344
94.5 x 31.5	STL.240.80	\$4,555	\$5,366	\$6,262
94.5 x 39.5	STL.240.100	\$4,747	\$5,486	\$6,311
94.5 x 47	STL.240.120	\$5,011	\$5,640	\$6,362



**Slenda Table with Power in Leg**  
height 29"

SIZE (Inch)	ORDER CODE	PRICE		
		Standard	Rustic	Fenix
	<b>Cutline Edge</b>			
	RAL/Raw			
71 x 31.5	STL.180.80.PWR/LEG	\$5,703	\$6,657	\$6,657
71 x 39.5	STL.180.100.PWR/LEG	\$5,900	\$6,778	\$6,778
71 x 47	STL.180.120.PWR/LEG	\$6,170	\$6,946	\$6,946
82.5 x 31.5	STL.210.80.PWR/LEG	\$5,986	\$6,827	\$6,827
82.5 x 39.5	STL.210.100.PWR/LEG	\$6,180	\$6,946	\$6,946
82.5 x 47	STL.210.120.PWR/LEG	\$6,444	\$7,104	\$7,104
94.5 x 31.5	STL.240.80.PWR/LEG	\$6,088	\$6,886	\$6,886
94.5 x 39.5	STL.240.100.PWR/LEG	\$6,285	\$7,009	\$7,009
94.5 x 47	STL.240.120.PWR/LEG	\$6,553	\$7,165	\$7,165



**Slenda Table with Power in Table Top**  
height 29"

SIZE (Inch)	ORDER CODE	PRICE		
		Standard	Rustic	Fenix
	<b>Cutline Edge</b>			
	RAL/Raw			
71 x 31.5	STL.180.80.WPV	\$5,440	\$6,400	\$7,438
71 x 39.5	STL.180.100.WPV	\$5,639	\$6,525	\$7,493
71 x 47	STL.180.120.WPV	\$5,897	\$6,685	\$7,561
82.5 x 31.5	STL.210.80.WPV	\$5,717	\$6,564	\$7,506
82.5 x 39.5	STL.210.100.WPV	\$5,909	\$6,685	\$7,549
82.5 x 47	STL.210.120.WPV	\$6,171	\$6,842	\$7,606
94.5 x 31.5	STL.240.80.WPV	\$5,817	\$6,628	\$7,524
94.5 x 39.5	STL.240.100.WPV	\$6,009	\$6,748	\$7,573
94.5 x 47	STL.240.120.WPV	\$6,273	\$6,902	\$7,624

Specify power module option - see page 100 for more information. Price includes cut-out/s in table top, power flap, cable tray and power modules.

Shroud and power flap in a contrasting finish to framework	RAL/Raw: + \$203	Vintage: + \$406	Custom cut-out	+ \$185
--	------------------	------------------	----------------	---------



# FOUNDRY GIANT

---

Manufactured from a re-purposed material, Foundry Giant has been designed with both sustainability and practicality at its core. The strong, geometric rebar base is offered in a wide range of colors.



## FEATURES

---

- Recycled steel rebar frame
- Base supplied in three pieces for easy install
- Available in a wide range of frame and top finishes
- Large diameters available with or without power



STEPS TO SPECIFY

Follow our guide and customize our products to suit your space

- 1 2 3 4

Select Size: 70.8 or 82.6" diameter

- 1 2 3 4

Select Power: Non-powered or one/two trio power units



**Trio Power Unit**  
2x Power Outlet & 1x Twin USB Charge  
(1x Type-A & 1x Type-C)  
Available in Black  
Includes cable management.

- 1 2 3 4

Select Frame Finish: Raw finish is unavailable due to the nature of the material

RAL metal frame finishes

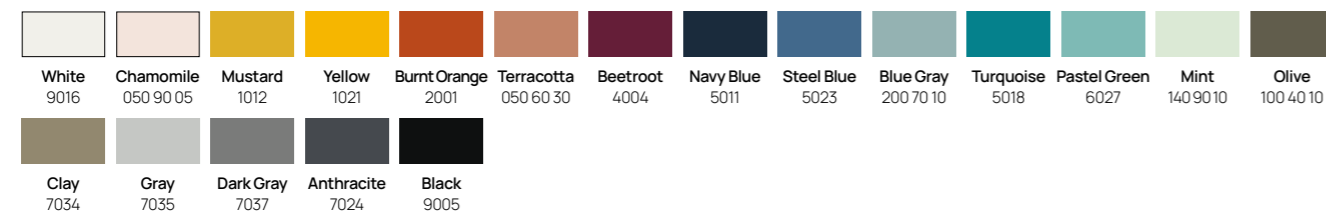

- 1 2 3 4

Select Top Finish:



**Cutline edge**  
top thickness 0.9"

Cutline Standard Laminate



Cutline Fenix



Cutline Rustic

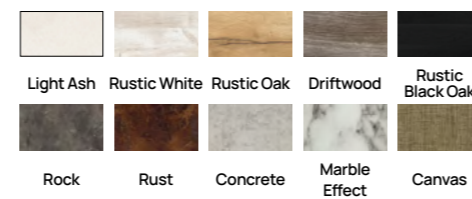

**Foundry Giant Table**  
height 29"

SIZE (Inch)	ORDER CODE	PRICE		
		Standard	Rustic	Fenix
71 dia	FDG.180D	\$10,037	\$11,826	\$13,469
82.5 dia	FDG.210D	\$11,989	\$12,814	\$14,542



**Foundry Giant Table with 1 Power**  
height 29"

SIZE (Inch)	ORDER CODE	PRICE		
		Standard	Rustic	Fenix
71 dia	FDG.180D.WPV/1PM	\$11,152	\$13,141	\$14,967
82.5 dia	FDG.210D.WPV/1PM	\$13,320	\$14,238	\$16,157



**Foundry Giant Table with 2 Power**  
height 29"

SIZE (Inch)	ORDER CODE	PRICE		
		Standard	Rustic	Fenix
71 dia	FDG.180D.WPV/2PM	\$12,265	\$14,455	\$16,462
82.5 dia	FDG.210D.WPV/2PM	\$14,656	\$15,662	\$17,774

Central metal strip in an alternative finish to framework RAL: +\$782

## Seating - Soft Seating

ALTO SOFA	158
* BAE	132
BLUME LOUNGE CHAIR	154
BOHO	138
DOWNTOWN	194
DRUM	212
ERA	190
FLORD	162
HOME	172
HUDDLE MODULAR	206
ILK	178
JIG MODULAR	202
JIG SOFA	198
* SAIL SOFA	124
SCANDI	186
SCRUM SOFA	170
SNUG MODULAR	146
SNUG SOFA	150
TROST	142

\* New product



# SAIL SOFA

\* NEW \*

The Sail booth system addresses privacy for commercial office interiors, by providing a segregated space to collaborate, learn, focus, or relax. It's a refined seating system that allows flexibility and consolidation of workspace in a given area to escape without the need for partitioning or division, promoting collaboration, creativity, and deep concentrative thinking. The ergonomically designed booth has exemplary comfort levels.



## FEATURES

Work independently in comfort

Elegant organic profile to suit most schemes

Generous proportions

Soft, sleek, design with curved corners

High-back enhances privacy



## STEPS TO SPECIFY

Follow our guide and customize our products to suit your space

---

1 2 3

Select Size: One or Two seater sofa

---

1 2 3

Select Fabric: Available in fabric bands 1 - 8

Fabrics  
See pages 406-415

---

1 2 3

Select Accessories:



Peggy Laptop  
Table



Cushions

The Peggy Laptop Table is the perfect supplementary product and is available as an accessory at a reduced price of \$909. See page 296 for more information.





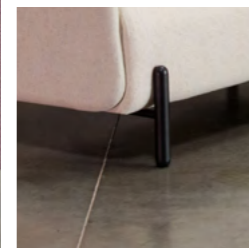

Black fine textured legs

Exemplary comfort



Elegant organic profile

Easy assembly





**Sail Sofa One Seater**

width 38.5, depth 31, height 54.5, seat height 18"

FABRIC	ORDER CODE	PRICE
1	SIF.1SSF.FBB	\$6,273
2	SIF.1SSF.FBC	\$6,485
3	SIF.1SSF.FBD	\$6,653
4	SIF.1SSF.FBE	\$6,824
5	SIF.1SSF.FBF	\$7,077
6	SIF.1SSF.FBG	\$7,584
7	SIF.1SSF.FBH	\$8,093
8	SIF.1SSF.FBI	\$8,600



**Sail Sofa Two Seater**

width 60, depth 31, height 54.5, seat height 18"

FABRIC	ORDER CODE	PRICE
1	SIF.2SSF.FBB	\$7,578
2	SIF.2SSF.FBC	\$7,881
3	SIF.2SSF.FBD	\$8,124
4	SIF.2SSF.FBE	\$8,366
5	SIF.2SSF.FBF	\$8,729
6	SIF.2SSF.FBG	\$9,457
7	SIF.2SSF.FBH	\$10,184
8	SIF.2SSF.FBI	\$10,912

Sail is also available as a Two Seater & Four Seater Booth, see page 256 for more information.



# BAE

\* NEW \*

Bae is an organic shaped seating system with a skeletal timber form that allows endless sweeping configurations that can be easily linked together but allows separate conversational islands. To reduce environmental impacts, both the material used in the design are sustainable and the product can easily be deconstructed for recycling, minimising the impact on the environment.



## FEATURES

- Enveloping relaxed comfort
- Five optimum units for endless composition freedom
- Soft organic shapes that allow a chain of united environments but have a functional divisional surface
- Simple assembly and configuration
- Sustainable materials - side pressed bamboo base board
- Designed for deconstruction at end of life
- Adjustable feet
- Delivered KD to site and easily constructed



STEPS TO SPECIFY



Follow our guide and customize our products to suit your space

- 1 2 3 4

Select Unit (s): 90-degree Inwards, 90-degree Outwards, 180-degree, 30-degree and Straight 1700

- 1 2 3 4

Frame Finish:

Baseboard finish	Leg finish
	
Bamboo	Natural Ash

- 1 2 3 4

Select Fabric: Available in fabric grades 1-8

Fabrics  
See pages 406-415

- 1 2 3 4

Select Accessories:

	
Peggy Laptop Table	Duet Power

The Peggy Laptop Table is the perfect supplementary product and is available as an accessory at a reduced price of \$909. See page 296 for more information.



**Bae Sofa 90-degree Inwards Unit**  
width 68.5, depth 68.5, height 29"

FABRIC	ORDER CODE	PRICE
1	BAE2.FBB	\$9,264
2	BAE2.FBC	\$9,495
3	BAE2.FBD	\$9,680
4	BAE2.FBE	\$9,863
5	BAE2.FBF	\$10,141
6	BAE2.FBG	\$10,692
7	BAE2.FBH	\$11,246
8	BAE2.FBI	\$11,797



**Bae Sofa 90-degree Outwards Unit**  
width 84.5, depth 42.5, height 16"

FABRIC	ORDER CODE	PRICE
1	BAE1.FBB	\$9,264
2	BAE1.FBC	\$9,495
3	BAE1.FBD	\$9,680
4	BAE1.FBE	\$9,863
5	BAE1.FBF	\$10,141
6	BAE1.FBG	\$10,692
7	BAE1.FBH	\$11,246
8	BAE1.FBI	\$11,797



**Bae Sofa 180-degree Unit**  
width 68.5, depth 68.5, height 29"

FABRIC	ORDER CODE	PRICE
1	BAE5.FBB	\$7,170
2	BAE5.FBC	\$7,333
3	BAE5.FBD	\$7,465
4	BAE5.FBE	\$7,596
5	BAE5.FBF	\$7,792
6	BAE5.FBG	\$8,188
7	BAE5.FBH	\$8,582
8	BAE5.FBI	\$8,977



**Bae Sofa 30-degree Unit**  
width 65, depth 44, height 29"

FABRIC	ORDER CODE	PRICE
1	BAE3.FBB	\$6,497
2	BAE3.FBC	\$6,657
3	BAE3.FBD	\$6,783
4	BAE3.FBE	\$6,907
5	BAE3.FBF	\$7,097
6	BAE3.FBG	\$7,474
7	BAE3.FBH	\$7,854
8	BAE3.FBI	\$8,232



**Bae Sofa Straight 1700 Unit**  
width 67, depth 44, height 29"

FABRIC	ORDER CODE	PRICE
1	BAE4.FBB	\$6,595
2	BAE4.FBC	\$6,746
3	BAE4.FBD	\$6,869
4	BAE4.FBE	\$6,989
5	BAE4.FBF	\$7,173
6	BAE4.FBG	\$7,539
7	BAE4.FBH	\$7,905
8	BAE4.FBI	\$8,270



Side pressed Bamboo baseboard



Solid Ash Legs

Adjustable Feet



# BOHO

---

Boho provides the perfect spot to unwind and catch your breath. Become enveloped in the delightfully soft bulbous armchair and experience the welcoming reassurance and warmth created by its curvaceous design. Complement your interior design and customise your Boho armchair with a range of beautiful upholstery finishes to create an alluring, elegant and comfortable statement chair that breathes relief and relaxation into any environment.



## FEATURES

---

- Organic inflated statement chair
- Designed to allure comfort
- Ruched upholstery detailing
- 100% recyclable
- Replaceable covers
- Black frame finish

**We have a limited list of approved fabrics that are suitable for the contours of the Boho Chair. Please refer to the Frövi sales office for further advice or the fabric band charts for more detail.**

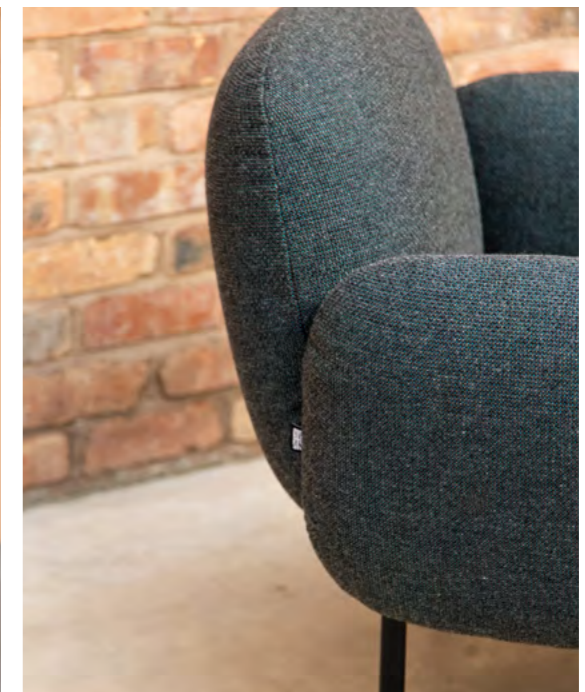

## STEPS TO SPECIFY

Follow our guide and customize our products to suit your space

1 2

Select Fabric: Available in limited selected fabrics due to suitability

Fabrics  
See pages 406-415

1 2

Select Accessories:



Peggy  
Laptop Table

The Peggy Laptop Table is the perfect supplementary product and is available as an accessory at a reduced price of \$909. See page 296 for more information.



**Boho Chair**  
width 34, depth 29.5, height 33.5, seat height 17.5"



FABRIC	ORDER CODE	PRICE
1	BHO.FBB	\$3,039
2	BHO.FBC	\$3,274
3	BHO.FBD	\$3,460
4	BHO.FBE	\$3,648
5	BHO.FBF	\$3,930
6	BHO.FBG	\$4,492
7	BHO.FBH	\$5,054
8	BHO.FBI	\$5,617

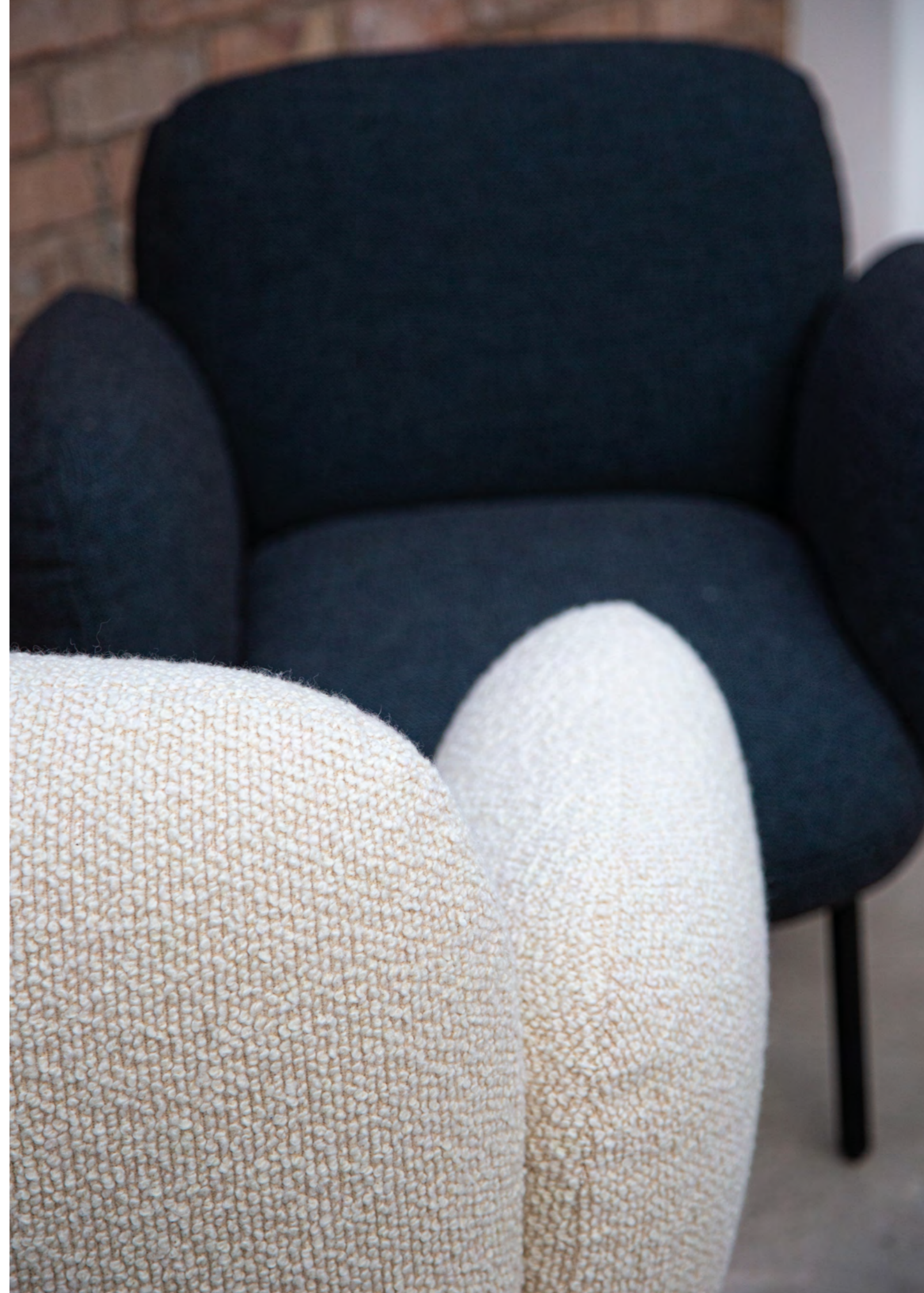

# TROST

---

Inspired by the Swedish word for 'comforting', the Trost chair has been designed to envelope and wrap you in its soft, reassuring form. Trost's choice of materials have been carefully considered to create maximum comfort with minimum impact on the built environment.



## FEATURES

---

A statement chair with soft, reassuring form

Designed with moulded foam for maximum comfort

High and low versions available

**We have a limited list of approved fabrics that are suitable for the contours of the Trost Chair. Please refer to the Frövi sales office for further advice or the fabric band charts for more detail.**





**STEPS TO SPECIFY**

Follow our guide and customize our products to suit your space

- ① ② ③

Select Height: High or Low

- ① ② ③

Select Frame Finish: Choose from selected finishes

Wood frame finishes



Natural Oak Black Oak

- ① ② ③ ④

Select Accessories:



Peggy Laptop Table

The Peggy Laptop Table is the perfect supplementary product and is available as an accessory at a reduced price of \$909. See page 296 for more information.

- ① ② ③

Select Fabric: Available in limited selected fabrics due to suitability

Fabrics  
See pages 406-415



**Trost High**  
width 37, depth 33.5, height 45, seat height 15.5"



**Trost Low**  
width 37, depth 29.5, height 31.5, seat height 15.5"

FABRIC	ORDER CODE		PRICE
	Natural Oak Frame	Black Oak Frame	
1	TRC.HHT.4W1.NOK.FBB	TRC.HHT.4W1.BOK.FBB	\$4,883
2	TRC.HHT.4W1.NOK.FBC	TRC.HHT.4W1.BOK.FBC	\$5,034
3	TRC.HHT.4W1.NOK.FBD	TRC.HHT.4W1.BOK.FBD	\$5,187
4	TRC.HHT.4W1.NOK.FBE	TRC.HHT.4W1.BOK.FBE	\$5,410
5	TRC.HHT.4W1.NOK.FBF	TRC.HHT.4W1.BOK.FBF	\$5,637
6	TRC.HHT.4W1.NOK.FBG	TRC.HHT.4W1.BOK.FBG	\$6,085
7	TRC.HHT.4W1.NOK.FBH	TRC.HHT.4W1.BOK.FBH	\$6,533
8	TRC.HHT.4W1.NOK.FBI	TRC.HHT.4W1.BOK.FBI	\$6,983

FABRIC	ORDER CODE		PRICE
	Natural Oak Frame	Black Oak Frame	
1	TRC.LHT.4W1.NOK.FBB	TRC.LHT.4W1.BOK.FBB	\$4,296
2	TRC.LHT.4W1.NOK.FBC	TRC.LHT.4W1.BOK.FBC	\$4,446
3	TRC.LHT.4W1.NOK.FBD	TRC.LHT.4W1.BOK.FBD	\$4,591
4	TRC.LHT.4W1.NOK.FBE	TRC.LHT.4W1.BOK.FBE	\$4,811
5	TRC.LHT.4W1.NOK.FBF	TRC.LHT.4W1.BOK.FBF	\$5,032
6	TRC.LHT.4W1.NOK.FBG	TRC.LHT.4W1.BOK.FBG	\$5,476
7	TRC.LHT.4W1.NOK.FBH	TRC.LHT.4W1.BOK.FBH	\$5,917
8	TRC.LHT.4W1.NOK.FBI	TRC.LHT.4W1.BOK.FBI	\$6,358



# SNUG MODULAR

---

Configure your ideal sofa with the Snug range of modular seating. Craft a unique arrangement for your space, with ultra-deep seats, beautiful styling and pillow edge detailing, the Snug range gives you an unrivalled level of comfort and relaxation. With seven unit choices allowing a multitude of seamless configurations, you can easily create the right sofa shape for any space.



## FEATURES

---

- Configurable modular seating
- Choose from 7 units for unique combinations
- Ultra-deep foam seats for extreme comfort
- Simple pillow edge detail
- Black frame finish



STEPS TO SPECIFY

Follow our guide and customize our products to suit your space

- 1
- 2
- 3
- 4

Select Size: Single or Two Seater

- 1
- 2
- 3
- 4

Select Configuration: Piece together modular units. Example configuration shown below



- 1
- 2
- 3
- 4

Select Fabric: Available in fabric grades 1-8 & leather 1-3

Fabrics  
See pages 406-415

- 1
- 2
- 3
- 4

Select Accessories:

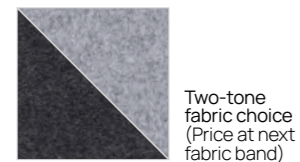

The Peggy Laptop Table is the perfect supplementary product and is available as an accessory at a reduced price of \$909. See page 296 for more information.



For more information on Accessories, see page 366.



**Snug Modular** Left-hand Single Seater  
width 39.5, depth 33, height 34.5, seat height 17.5"

FABRIC	ORDER CODE	PRICE
1	SM1L.BK.FBB	\$4,145
2	SM1L.BK.FBC	\$4,384
3	SM1L.BK.FBD	\$4,623
4	SM1L.BK.FBE	\$4,984
5	SM1L.BK.FBF	\$5,343
6	SM1L.BK.FBG	\$6,061
7	SM1L.BK.FBH	\$6,778
8	SM1L.BK.FBI	\$7,498



**Snug Modular** Right-hand Single Seater  
width 39.5, depth 33, height 34.5, seat height 17.5"

FABRIC	ORDER CODE	PRICE
1	SM1R.BK.FBB	\$4,145
2	SM1R.BK.FBC	\$4,384
3	SM1R.BK.FBD	\$4,623
4	SM1R.BK.FBE	\$4,984
5	SM1R.BK.FBF	\$5,343
6	SM1R.BK.FBG	\$6,061
7	SM1R.BK.FBH	\$6,778
8	SM1R.BK.FBI	\$7,498



**Snug Modular** Corner  
width 32.5, depth 33, height 34.5, seat height 17.5"

FABRIC	ORDER CODE	PRICE
1	SMCL.BK.FBB	\$4,322
2	SMCL.BK.FBC	\$4,563
3	SMCL.BK.FBD	\$4,802
4	SMCL.BK.FBE	\$5,161
5	SMCL.BK.FBF	\$5,520
6	SMCL.BK.FBG	\$6,240
7	SMCL.BK.FBH	\$6,960
8	SMCL.BK.FBI	\$7,677



**Snug Modular** Left-hand Two Seater  
width 72, depth 33, height 34.5, seat height 17.5"

FABRIC	ORDER CODE	PRICE
1	SM2L.BK.FBB	\$4,706
2	SM2L.BK.FBC	\$5,042
3	SM2L.BK.FBD	\$5,377
4	SM2L.BK.FBE	\$5,879
5	SM2L.BK.FBF	\$6,385
6	SM2L.BK.FBG	\$7,390
7	SM2L.BK.FBH	\$8,393
8	SM2L.BK.FBI	\$9,400



**Snug Modular** Right-hand Two Seater  
width 72, depth 33, height 34.5, seat height 17.5"

FABRIC	ORDER CODE	PRICE
1	SM2R.BK.FBB	\$4,706
2	SM2R.BK.FBC	\$5,042
3	SM2R.BK.FBD	\$5,377
4	SM2R.BK.FBE	\$5,879
5	SM2R.BK.FBF	\$6,385
6	SM2R.BK.FBG	\$7,390
7	SM2R.BK.FBH	\$8,393
8	SM2R.BK.FBI	\$9,400



**Snug Modular** Straight Seater  
width 32.5/65.5, depth 33, height 34.5, seat height 17.5"

FABRIC	ORDER CODE	PRICE	ORDER CODE	PRICE
		Single Seater	Two Seater	
B	SMSL.BK.FBB	\$3,695	SMDL.DL.FBB	\$4,706
C	SMSL.BK.FBC	\$3,885	SMDL.BK.FBC	\$5,042
D	SMSL.BK.FBD	\$4,076	SMDL.BK.FBD	\$5,377
E	SMSL.BK.FBE	\$4,368	SMDL.BK.FBE	\$5,879
F	SMSL.BK.FBF	\$4,654	SMDL.BK.FBF	\$6,385
G	SMSL.BK.FBG	\$5,229	SMDL.BK.FBG	\$7,390
H	SMSL.BK.FBH	\$5,802	SMDL.BK.FBH	\$8,393
I	SMSL.BK.FBI	\$6,377	SMDL.BK.FBI	\$9,400

# SNUG SOFA

---

True to its name, Snug Sofa is built with comfort at its core. The simple, soft design brings a homey feel to any interior scheme.



## FEATURES

---

- Ultra-deep foam seats for extreme comfort
- Simple pillow edge detail
- Black frame finish



STEPS TO SPECIFY

Follow our guide and customize our products to suit your space

1 2 3

Select Size: Single, Two or Three Seater

1 2 3

Select Fabric: Available in fabric grades 1-8 & leather 1-3

Fabrics  
See pages 406-415

1 2 3

Select Accessories:

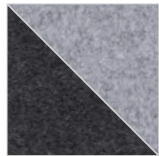

Two-tone fabric choice (Price at next fabric band)



Cushions



Peggy Laptop Table

The Peggy Laptop Table is the perfect supplementary product and is available as an accessory at a reduced price of \$909. See page 296 for more information.



Duet Power

For more information on Accessories, see page 366.



**Snug Sofa Single Seater**  
width 39, depth 33, height 34.5, seat height 18"

FABRIC	ORDER CODE	PRICE
1	SF1L.FBB	\$5,141
2	SF1L.FBC	\$5,587
3	SF1L.FBD	\$6,031
4	SF1L.FBE	\$6,695
5	SF1L.FBF	\$7,362
6	SF1L.FBG	\$8,685
7	SF1L.FBH	\$10,019
8	SF1L.FBI	\$11,346



**Snug Sofa Two Seater**  
width 65, depth 33, height 34.5, seat height 18"

FABRIC	ORDER CODE	PRICE
1	SF2L.FBB	\$6,500
2	SF2L.FBC	\$6,985
3	SF2L.FBD	\$7,459
4	SF2L.FBE	\$8,181
5	SF2L.FBF	\$8,899
6	SF2L.FBG	\$10,341
7	SF2L.FBH	\$11,776
8	SF2L.FBI	\$13,214



**Snug Sofa Three Seater**  
width 84, depth 33, height 34.5, seat height 18"

FABRIC	ORDER CODE	PRICE
1	SF3L.FBB	\$8,068
2	SF3L.FBC	\$8,680
3	SF3L.FBD	\$9,294
4	SF3L.FBE	\$10,207
5	SF3L.FBF	\$11,127
6	SF3L.FBG	\$12,961
7	SF3L.FBH	\$14,801
8	SF3L.FBI	\$16,636



# BLUME LOUNGE CHAIR

---

The Blume Lounge Chair delivers contemporary styling and an uncompromising attention to detail. With its unique low seating position, thick cushions and deep chamfer, it will add unrivalled style and comfort to your space. The Blume Lounge Chair is the perfect addition for any breakout and relaxation area.



## FEATURES

---

- Solid Ash construction
- Available in 3 frame finishes
- Webbed seat for comfort
- Low seating position

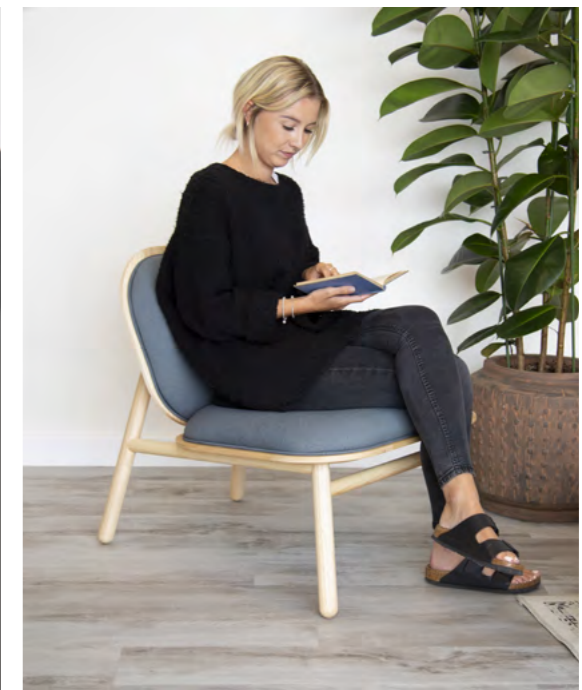

STEPS TO SPECIFY

Follow our guide and customize our products to suit your space

1 2

Select Finish: Choose from selected finishes.

Wood frame finishes



Oak (Stained Ash) Black Ash Natural Ash

1 2

Select Fabric: Available in fabric grades 1-8 & leather 1-3

Fabrics  
See pages 406-415



**Blume** Lounge Chair

width 26.5, depth 30.5, height 28.5, seat height 16"

FABRIC	ORDER CODE			PRICE
	Oak (Stained Ash)	Black Ash	Natural Ash	
1	BMF.OCA.FBB	BMF.SBK.FBB	BMF.NAS.FBB	\$3,085
2	BMF.OCA.FBC	BMF.SBK.FBC	BMF.NAS.FBC	\$3,136
3	BMF.OCA.FBD	BMF.SBK.FBD	BMF.NAS.FBD	\$3,183
4	BMF.OCA.FBE	BMF.SBK.FBE	BMF.NAS.FBE	\$3,257
5	BMF.OCA.FBF	BMF.SBK.FBF	BMF.NAS.FBF	\$3,329
6	BMF.OCA.FBG	BMF.SBK.FBG	BMF.NAS.FBG	\$3,480
7	BMF.OCA.FBH	BMF.SBK.FBH	BMF.NAS.FBH	\$3,628
8	BMF.OCA.FBI	BMF.SBK.FBI	BMF.NAS.FBI	\$3,779



# ALTO SOFA

---

Deeply cushioned for maximum comfort, the Alto Sofa is available in three generous sizes. The soft shape and plush style creates a sense of residential luxury within commercial environments.



## FEATURES

---

- Black metal feet
- Extensive range of fabrics available
- Pillow edge detail
- Soft density foam





STEPS TO SPECIFY

Follow our guide and customize our products to suit your space

- 1 2 3

Select Size: Single, Two or Three Seater

- 1 2 3

Select Fabric: Available in fabric grades 1-8 & leather 1-3

Fabrics  
See pages 406-415

- 1 2 3

Select Accessories:



Duet Power



Cushions



Peggy  
Laptop Table

For more information on Accessories, see page 366.

The Peggy Laptop Table is the perfect supplementary product and is available as an accessory at a reduced price of \$909. See page 296 for more information.



**Alto Sofa** Single Seater  
width 37.5, depth 38, height 34.5, seat height 17.5"

FABRIC	ORDER CODE	PRICE
1	ALF.1SSSF.BK.FBB	\$3,954
2	ALF.1SSSF.BK.FBC	\$4,276
3	ALF.1SSSF.BK.FBD	\$4,593
4	ALF.1SSSF.BK.FBE	\$5,072
5	ALF.1SSSF.BK.FBF	\$5,550
6	ALF.1SSSF.BK.FBG	\$6,509
7	ALF.1SSSF.BK.FBH	\$7,473
8	ALF.1SSSF.BK.FBI	\$8,432



**Alto Sofa** Two Seater  
width 37.5, depth 38, height 34.5, seat height 17.5"

FABRIC	ORDER CODE	PRICE
1	ALF.2SSSF.BK.FBB	\$5,407
2	ALF.2SSSF.BK.FBC	\$5,796
3	ALF.2SSSF.BK.FBD	\$6,189
4	ALF.2SSSF.BK.FBE	\$6,783
5	ALF.2SSSF.BK.FBF	\$7,374
6	ALF.2SSSF.BK.FBG	\$8,554
7	ALF.2SSSF.BK.FBH	\$9,734
8	ALF.2SSSF.BK.FBI	\$10,914



**Alto Sofa** Three Seater  
width 37.5, depth 38, height 34.5, seat height 17.5"

FABRIC	ORDER CODE	PRICE
1	ALF.3SSSF.BK.FBB	\$6,771
2	ALF.3SSSF.BK.FBC	\$7,215
3	ALF.3SSSF.BK.FBD	\$7,657
4	ALF.3SSSF.BK.FBE	\$8,317
5	ALF.3SSSF.BK.FBF	\$8,982
6	ALF.3SSSF.BK.FBG	\$10,311
7	ALF.3SSSF.BK.FBH	\$11,640
8	ALF.3SSSF.BK.FBI	\$12,970



# FLORD

---

This versatile, modular system allows you to reconfigure your layout to suit the changing environment. Deep-cushioned for maximum comfort and a range of useful accessories.



## FEATURES

---

- Fully modular
  - Extensive range of accessories including power and lighting
  - Webbed seat for extra comfort
  - Contrast cross-stitch detail
  - Six upholstered units for simple configuration
  - Black frame
- We recommend fabrics with a minimum of 80% wool content for our Flord range. Please refer to the Frövi sales office for further advice.**





Co-ordinating cushions



Contrasting cross-stitch detail

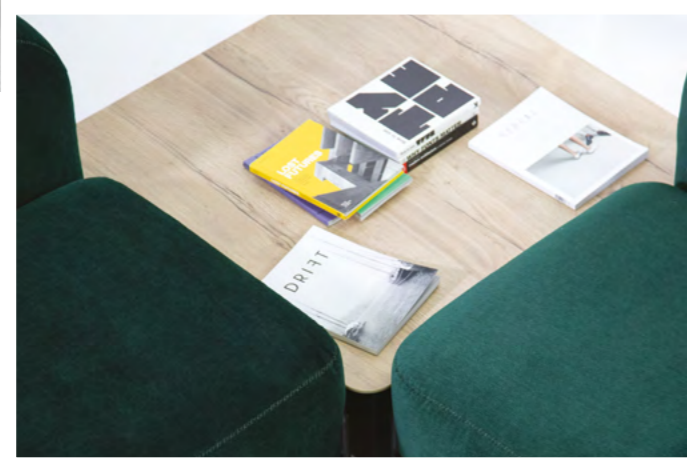

Metal or rustic laminate linking tables available, with or without power

Add multiple accessories to your configuration



STEPS TO SPECIFY

Follow our guide and customize our products to suit your space

- 1
- 2
- 3
- 4
- 5
- 6
- 7

Select Configuration: Piece together different products and accessories  
Example configurations shown below



- 1
- 2
- 3
- 4
- 5
- 6
- 7

Choose Fabric: Available in fabric grades 1-8

Fabrics  
See pages 406-415

- 1
- 2
- 3
- 4
- 5
- 6
- 7

Select Contrast Stitching Color: Available to match our Frövi RAL finishes



**Contrast stitching**  
(By request with no additional charge)

- 1
- 2
- 3
- 4
- 5
- 6
- 7

Select Table: With or without power

Coffee/Corner Table or Side Table. Coffee/Corner Tables are available with or without power.

Tables with Power are fitted with one Solo Power Unit - 1x Power Outlet and 1x Twin-USB (1x Type-A & 1x Type-C).



Solo Power Unit

- 1
- 2
- 3
- 4
- 5
- 6
- 7

Select Table Top Finish: (if applicable) Cutline edge laminate  
Side Table is available in Black metal finish only.



Cutline edge  
top thickness 1"

Cutline Rustic

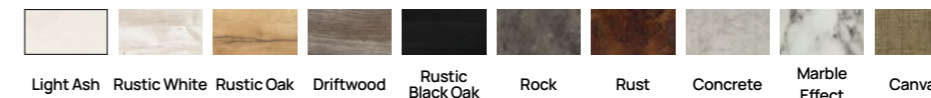

Cutline Fenix



- 1
- 2
- 3
- 4
- 5
- 6
- 7

Select Accessories:



Lumbar  
Cushion



Coat Hook  
1 supplied with  
every screen



Peggy  
Laptop Table

The Peggy Laptop Table is the perfect supplementary product and is available as an accessory at a reduced price of \$909. See page 296 for more information.

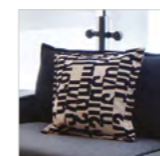

Standard  
Cushions



**Flord Right-Hand Single Seater**  
width 38, depth 38, height 28.5, seat height 18"

FABRIC	ORDER CODE	PRICE
1	FFRL.BK.FBB	\$5,154
2	FFRL.BK.FBC	\$5,401
3	FFRL.BK.FBD	\$5,645
4	FFRL.BK.FBE	\$6,009
5	FFRL.BK.FBF	\$6,371
6	FFRL.BK.FBG	\$7,102
7	FFRL.BK.FBH	\$7,835
8	FFRL.BK.FBI	\$8,566



**Flord Left-Hand Single Seater**  
width 38, depth 38, height 28.5, seat height 18"

FABRIC	ORDER CODE	PRICE
1	FFLL.BK.FBB	\$5,154
2	FFLL.BK.FBC	\$5,401
3	FFLL.BK.FBD	\$5,645
4	FFLL.BK.FBE	\$6,009
5	FFLL.BK.FBF	\$6,371
6	FFLL.BK.FBG	\$7,102
7	FFLL.BK.FBH	\$7,835
8	FFLL.BK.FBI	\$8,566



**Flord Straight Single Seater**  
width 28.5, depth 38, height 28.5, seat height 18"

FABRIC	ORDER CODE	PRICE
1	FF1L.BK.FBB	\$4,194
2	FF1L.BK.FBC	\$4,370
3	FF1L.BK.FBD	\$4,546
4	FF1L.BK.FBE	\$4,813
5	FF1L.BK.FBF	\$5,080
6	FF1L.BK.FBG	\$5,612
7	FF1L.BK.FBH	\$6,140
8	FF1L.BK.FBI	\$6,674



**Flord Ottoman**  
width 28.5, depth 28.5, height 18"

FABRIC	ORDER CODE	PRICE
1	FFOT.BK.FBB	\$2,995
2	FFOT.BK.FBC	\$3,105
3	FFOT.BK.FBD	\$3,215
4	FFOT.BK.FBE	\$3,380
5	FFOT.BK.FBF	\$3,544
6	FFOT.BK.FBG	\$3,877
7	FFOT.BK.FBH	\$4,210
8	FFOT.BK.FBI	\$4,544



**Flord 900 Screen** - Supplied with 1 Coat Hook  
width 35.5, depth 1.5, height 55"

FABRIC	ORDER CODE	PRICE
1	FFSC.90.BK.FBB	\$1,797
2	FFSC.90.BK.FBC	\$1,933
3	FFSC.90.BK.FBD	\$2,076
4	FFSC.90.BK.FBE	\$2,285
5	FFSC.90.BK.FBF	\$2,494
6	FFSC.90.BK.FBG	\$2,912
7	FFSC.90.BK.FBH	\$3,326
8	FFSC.90.BK.FBI	\$3,745



**Flord 660 Screen** - Supplied with 1 Coat Hook  
width 26, depth 1.5, height 55"

FABRIC	ORDER CODE	PRICE
1	FFSC.66.BK.FBB	\$1,797
2	FFSC.66.BK.FBC	\$1,933
3	FFSC.66.BK.FBD	\$2,076
4	FFSC.66.BK.FBE	\$2,285
5	FFSC.66.BK.FBF	\$2,494
6	FFSC.66.BK.FBG	\$2,912
7	FFSC.66.BK.FBH	\$3,326
8	FFSC.66.BK.FBI	\$3,745



**Flord Coffee/Corner Table**  
width 38, depth 38, height 12"

DESCRIPTION	ORDER CODE	PRICE	
		Rustic	Fenix
Without Power	FFCT.BK.96S.NPR	\$2,840	\$3,136
With Power 1x Solo Power Unit	FFCT.BK.96S.SP1/BK	\$3,279	\$3,581



**Flord Side Table**  
width 14, depth 14, height 20"

DESCRIPTION	ORDER CODE	PRICE
		Black
Side Table	FFST	\$865

# SCRUM SOFA

Scrum Sofa is a simple modular seating system designed to fit within our Colony or be used within an open plan area.



## FEATURES

- Webbed seat and back for maximum comfort
- Black frame and webbed detail
- 45° Bend - Fits neatly into any Colony configuration
- Includes linking brackets as standard

## STEPS TO SPECIFY

Follow our guide and customize our products to suit your space



Select Product: Straight or 45° Bend



**Scrum Sofa 45° Bend**  
width 47, depth 27.5, height 30.5, seat height 17.5"



**Scrum Sofa Straight**  
width 47, depth 27.5, height 30.5, seat height 17.5"



Select Fabric: Available in fabric grades 1-8

Fabrics  
See pages 406-415

FABRIC	ORDER CODE	PRICE
1	SCF.45.BK.FBB	\$2,552
2	SCF.45.BK.FBC	\$2,668
3	SCF.45.BK.FBD	\$2,786
4	SCF.45.BK.FBE	\$2,960
5	SCF.45.BK.FBF	\$3,138
6	SCF.45.BK.FBG	\$3,490
7	SCF.45.BK.FBH	\$3,842
8	SCF.45.BK.FBI	\$4,190

FABRIC	ORDER CODE	PRICE
1	SCF.ST.BK.FBB	\$2,867
2	SCF.ST.BK.FBC	\$3,006
3	SCF.ST.BK.FBD	\$3,146
4	SCF.ST.BK.FBE	\$3,358
5	SCF.ST.BK.FBF	\$3,567
6	SCF.ST.BK.FBG	\$3,993
7	SCF.ST.BK.FBH	\$4,411
8	SCF.ST.BK.FBI	\$4,833

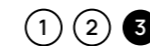

Select Accessories:



**Contrast stitching**  
(By request with no additional charge)

# HOME

---

With soft gentle curves, Home provides a residential feel to any commercial workplace. Creating privacy with the high-back versions or a more open feel with the low-back. Add additional practicality and manoeuvrability with castors or add laptop tables to provide a secluded working area.



## FEATURES

---

- Available on castors
- Soft lumbar support
- Webbed seat for extra comfort
- Black frame finish
- Optional integrated swivel laptop table
- High and low back versions





Available with castors



Laptop Table





STEPS TO SPECIFY

Follow our guide and customize our products to suit your space

- 1 2 3 4

Select Size: Single or Two Seater

- 1 2 3 4

Select Height: Sofa or High Sofa

- 1 2 3 4

Choose Fabric: Available in fabric grades 1-8

Fabrics  
See pages 406-415

- 1 2 3 4

Choose Additional Extras:



Laptop Table



Coat Hook  
(High-back sofa only)



Two-tone fabric choice  
(Price at next fabric band)



Castors  
Available in Stainless Steel



**Home Sofa Single Seater**  
width 42.5, depth 30.5, height 35.5, seat height 17.5"

FABRIC	ORDER CODE	PRICE
1	HOF.1SL.BK.NCA.FBB	\$6,340
2	HOF.1SL.BK.NCA.FBC	\$6,612
3	HOF.1SL.BK.NCA.FBD	\$6,883
4	HOF.1SL.BK.NCA.FBE	\$7,286
5	HOF.1SL.BK.NCA.FBF	\$7,694
6	HOF.1SL.BK.NCA.FBG	\$8,508
7	HOF.1SL.BK.NCA.FBH	\$9,319
8	HOF.1SL.BK.NCA.FBI	\$10,131



**Home Sofa Two Seater**  
width 67.5, depth 30.5, height 35.5, seat height 17.5"

FABRIC	ORDER CODE	PRICE
1	HOF.2SL.BK.NCA.FBB	\$7,974
2	HOF.2SL.BK.NCA.FBC	\$8,332
3	HOF.2SL.BK.NCA.FBD	\$8,686
4	HOF.2SL.BK.NCA.FBE	\$9,222
5	HOF.2SL.BK.NCA.FBF	\$9,754
6	HOF.2SL.BK.NCA.FBG	\$10,822
7	HOF.2SL.BK.NCA.FBH	\$11,888
8	HOF.2SL.BK.NCA.FBI	\$12,954



**Home High Sofa Single Seater**  
width 46.5, depth 32.5, height 56, seat height 17.5"

FABRIC	ORDER CODE	PRICE
1	HOF.1SH.BK.NCA.FBB	\$8,686
2	HOF.1SH.BK.NCA.FBC	\$9,185
3	HOF.1SH.BK.NCA.FBD	\$9,681
4	HOF.1SH.BK.NCA.FBE	\$10,427
5	HOF.1SH.BK.NCA.FBF	\$11,174
6	HOF.1SH.BK.NCA.FBG	\$12,664
7	HOF.1SH.BK.NCA.FBH	\$14,161
8	HOF.1SH.BK.NCA.FBI	\$15,653

One Coat Hook supplied per High Sofa



**Home High Sofa Two Seater**  
width 71.5, depth 32.5, height 56, seat height 17.5"

FABRIC	ORDER CODE	PRICE
1	HOF.2SH.BK.NCA.FBB	\$10,839
2	HOF.2SH.BK.NCA.FBC	\$11,503
3	HOF.2SH.BK.NCA.FBD	\$12,165
4	HOF.2SH.BK.NCA.FBE	\$13,157
5	HOF.2SH.BK.NCA.FBF	\$14,153
6	HOF.2SH.BK.NCA.FBG	\$16,142
7	HOF.2SH.BK.NCA.FBH	\$18,133
8	HOF.2SH.BK.NCA.FBI	\$20,125

One Coat Hook supplied per High Sofa

Home Accessories

DESCRIPTION	ORDER CODE	PRICE
Castors	WCA	\$571
Laptop Table	HOLT.BK	\$1,254
Coat Hook	HOHK	\$66

One Coat Hook supplied per High Sofa FOC

# ILK

---

With its soft flowing lines, Ilk makes a statement bringing the warmth of home into a working environment.



## FEATURES

---

- Durable injection-moulded foam construction
- Wide choice of frame styles - timber, wire and swivel
- Extensive range of fabrics
- High and low versions available
- Single and two seater
- Quick Ship available on selected variations and finishes, see pages 12 - 17 for more information.



## STEPS TO SPECIFY

Follow our guide and customize our products to suit your space

1 2 3 4 5 6

Select Size: Single or Two Seater

1 2 3 4 5 6

Select Height: High or Low

1 2 3 4 5 6

Select Frame:



4 Leg



Sled



Swivel 4-star  
Excludes Two  
Seater



Tilt  
Excludes Two  
Seater

1 2 3 4 5 6

Select Frame Finish: Choose from selected frame finishes

### Ilk 4 Leg

Wood frame finishes

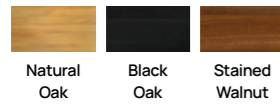

### Ilk Swivel 4-star / Tilt

Metal frame finish



### Ilk Sled

RAL metal frame finishes

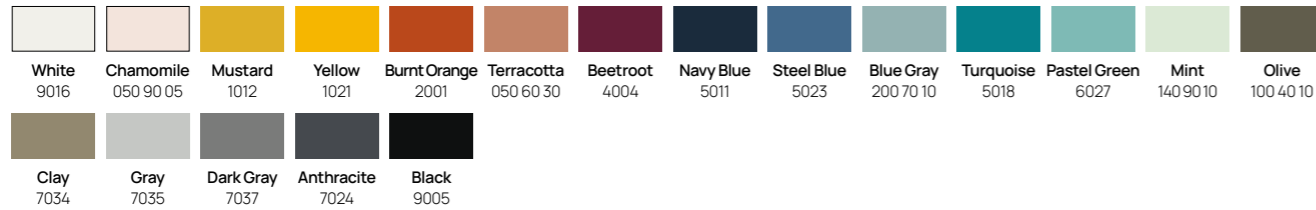

### Ilk Sled

Metal frame finish



1 2 3 4 5 6

Select Fabric: Available in fabric grades 1-8 & leather 1-3

Fabrics

See pages 406-415

1 2 3 4 5 6

Select Accessories:

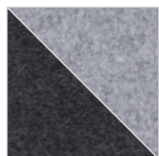

Two-tone  
fabric choice  
(Price at next  
fabric band)



Contrast  
stitching  
(By request with  
no additional  
charge)



Peggy  
Laptop Table

The Peggy Laptop Table is the perfect supplementary product and is available as an accessory at a reduced price of \$909. See page 296 for more information.



**Ilk High 4 Leg**

width 31, depth 31.5, height 43.5, seat height 16.5"

FABRIC	ORDER CODE	PRICE
1	ILF1SH.4W1.FBB	\$2,716
2	ILF1SH.4W1.FBC	\$3,008
3	ILF1SH.4W1.FBD	\$3,314
4	ILF1SH.4W1.FBE	\$3,633
5	ILF1SH.4W1.FBF	\$3,968
6	ILF1SH.4W1.FBG	\$4,322
7	ILF1SH.4W1.FBH	\$4,675
8	ILF1SH.4W1.FBI	\$5,028

Leather pricing available upon application.

**Ilk High Sled**

width 31, depth 31.5, height 43.5, seat height 16.5"

FABRIC	ORDER CODE	PRICE
1	ILF1SH.SL1.FBB	\$2,501
2	ILF1SH.SL1.FBC	\$2,793
3	ILF1SH.SL1.FBD	\$3,099
4	ILF1SH.SL1.FBE	\$3,419
5	ILF1SH.SL1.FBF	\$3,754
6	ILF1SH.SL1.FBG	\$4,108
7	ILF1SH.SL1.FBH	\$4,460
8	ILF1SH.SL1.FBI	\$4,813

Leather pricing available upon application.

**Ilk Low 4 Leg**

width 30.5, depth 30.5, height 32.5, seat height 16.5"

FABRIC	ORDER CODE	PRICE
1	ILF1SL.4W1.FBB	\$2,101
2	ILF1SL.4W1.FBC	\$2,375
3	ILF1SL.4W1.FBD	\$2,620
4	ILF1SL.4W1.FBE	\$2,875
5	ILF1SL.4W1.FBF	\$3,142
6	ILF1SL.4W1.FBG	\$3,424
7	ILF1SL.4W1.FBH	\$3,706
8	ILF1SL.4W1.FBI	\$3,988

Leather pricing available upon application.

**Ilk Low Sled**

width 30.5, depth 30.5, height 32.5, seat height 16.5"

FABRIC	ORDER CODE	PRICE
1	ILF1SL.SL1.FBB	\$1,886
2	ILF1SL.SL1.FBC	\$2,161
3	ILF1SL.SL1.FBD	\$2,405
4	ILF1SL.SL1.FBE	\$2,660
5	ILF1SL.SL1.FBF	\$2,928
6	ILF1SL.SL1.FBG	\$3,210
7	ILF1SL.SL1.FBH	\$3,492
8	ILF1SL.SL1.FBI	\$3,773

Leather pricing available upon application.

**Ilk High Swivel 4-star**

width 31, depth 31.5, height 43.5, seat height 16.5"

FABRIC	ORDER CODE	PRICE
		<b>Black Frame</b>
1	ILF1SH.4SS.FBB	\$2,376
2	ILF1SH.4SS.FBC	\$2,668
3	ILF1SH.4SS.FBD	\$2,973
4	ILF1SH.4SS.FBE	\$3,293
5	ILF1SH.4SS.FBF	\$3,628
6	ILF1SH.4SS.FBG	\$3,981
7	ILF1SH.4SS.FBH	\$4,335
8	ILF1SH.4SS.FBI	\$4,688

Leather pricing available upon application.

**Ilk Tilt**

width 31, depth 31.5, height 43.5, seat height 16.5"

FABRIC	ORDER CODE	PRICE
		<b>Black Frame</b>
1	ILF1SH.4ST.FBB	\$2,376
2	ILF1SH.4ST.FBC	\$2,668
3	ILF1SH.4ST.FBD	\$2,973
4	ILF1SH.4ST.FBE	\$3,293
5	ILF1SH.4ST.FBF	\$3,628
6	ILF1SH.4ST.FBG	\$3,981
7	ILF1SH.4ST.FBH	\$4,335
8	ILF1SH.4ST.FBI	\$4,688

Leather pricing available upon application.

**Ilk Low Swivel 4-star**

width 30.5, depth 30.5, height 32.5, seat height 16.5"

FABRIC	ORDER CODE	PRICE
		<b>Black Frame</b>
1	ILF1SL.4SS.FBB	\$1,762
2	ILF1SL.4SS.FBC	\$2,036
3	ILF1SL.4SS.FBD	\$2,280
4	ILF1SL.4SS.FBE	\$2,535
5	ILF1SL.4SS.FBF	\$2,803
6	ILF1SL.4SS.FBG	\$3,084
7	ILF1SL.4SS.FBH	\$3,366
8	ILF1SL.4SS.FBI	\$3,648

Leather pricing available upon application.



**Ilk Two Seater Low 4 Leg**  
width 56.5, depth 32, height 32.5, seat height 16.5"



FABRIC	ORDER CODE	PRICE
1	ILF.2SL.4W1.FBB	\$6,989
2	ILF.2SL.4W1.FBC	\$7,225
3	ILF.2SL.4W1.FBD	\$7,465
4	ILF.2SL.4W1.FBE	\$7,821
5	ILF.2SL.4W1.FBF	\$8,175
6	ILF.2SL.4W1.FBG	\$8,885
7	ILF.2SL.4W1.FBH	\$9,594
8	ILF.2SL.4W1.FBI	\$10,302
LEATHER	PRICE	
L1	ILF.2SL.4W1.FBL1	\$10,302
L2	ILF.2SL.4W1.FBL2	\$11,621
L3	ILF.2SL.4W1.FBL3	\$12,503



**Ilk Two Seater High 4 Leg**  
width 56.5, depth 32, height 43.5, seat height 16.5"



FABRIC	ORDER CODE	PRICE
1	ILF.2SH.4W1.FBB	\$7,620
2	ILF.2SH.4W1.FBC	\$7,878
3	ILF.2SH.4W1.FBD	\$8,138
4	ILF.2SH.4W1.FBE	\$8,526
5	ILF.2SH.4W1.FBF	\$8,911
6	ILF.2SH.4W1.FBG	\$9,686
7	ILF.2SH.4W1.FBH	\$10,464
8	ILF.2SH.4W1.FBI	\$11,237
LEATHER	PRICE	
L1	ILF.2SH.4W1.FBL1	\$11,237
L2	ILF.2SH.4W1.FBL2	\$12,278
L3	ILF.2SH.4W1.FBL3	\$13,180



**Ilk Two Seater Low Sled**  
width 56.5, depth 32, height 32.5, seat height 16.5"

FABRIC	ORDER CODE	PRICE
1	ILF.2SL.SL1.FBB	\$6,427
2	ILF.2SL.SL1.FBC	\$6,681
3	ILF.2SL.SL1.FBD	\$6,933
4	ILF.2SL.SL1.FBE	\$7,309
5	ILF.2SL.SL1.FBF	\$7,690
6	ILF.2SL.SL1.FBG	\$8,445
7	ILF.2SL.SL1.FBH	\$9,205
8	ILF.2SL.SL1.FBI	\$9,960
LEATHER	PRICE	
L1	ILF.2SL.SL1.FBL1	\$9,960
L2	ILF.2SL.SL1.FBL2	\$11,225
L3	ILF.2SL.SL1.FBL3	\$12,132



**Ilk Two Seater High Sled**  
width 56.5, depth 32, height 43.5, seat height 16.5"

FABRIC	ORDER CODE	PRICE
1	ILF.2SH.SL1.FBB	\$7,184
2	ILF.2SH.SL1.FBC	\$7,463
3	ILF.2SH.SL1.FBD	\$7,737
4	ILF.2SH.SL1.FBE	\$8,158
5	ILF.2SH.SL1.FBF	\$8,568
6	ILF.2SH.SL1.FBG	\$9,405
7	ILF.2SH.SL1.FBH	\$10,241
8	ILF.2SH.SL1.FBI	\$11,072
LEATHER	PRICE	
L1	ILF.2SH.SL1.FBL1	\$11,072
L2	ILF.2SH.SL1.FBL2	\$12,081
L3	ILF.2SH.SL1.FBL3	\$13,021

# SCANDI

---

Naturally named, Scandi is handcrafted using traditional methods. Embracing the cool simplicity and clean lines of Scandinavian style.



## FEATURES

---

- Handcrafted wooden frame
- Webbed seat for maximum comfort
- Wide range of timber finishes
- Available in fabric and leather



## STEPS TO SPECIFY

Follow our guide and customize our products to suit your space

1 2

Select Frame Finish: Choose from selected finishes

Wood frame finishes



Natural Oak Black Oak

1 2

Select Fabric: Available in fabric grades 1-8 & leather 1-3

Fabrics

See pages 406-415



### Scandi Single Seater Armchair

width 28.5, depth 30.5, height 29.5, seat height 17"

FABRIC	ORDER CODE	PRICE
1	SAF1.FBB	\$3,724
2	SAF1.FBC	\$3,785
3	SAF1.FBD	\$3,846
4	SAF1.FBE	\$3,934
5	SAF1.FBF	\$4,020
6	SAF1.FBG	\$4,203
7	SAF1.FBH	\$4,381
8	SAF1.FBI	\$4,561

Fixed cushions available - \$292



# ERA

---

Graceful contemporary design, combining comfort and practicality, Era is a versatile range at home in any environment.



## FEATURES

---

Wide, contoured seat with soft foam for superb comfort

Choice of frame options

Extensive range of fabrics

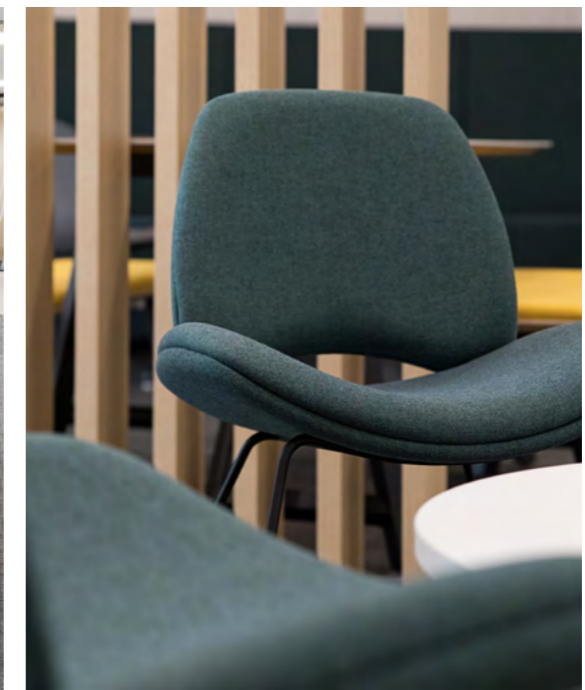



STEPS TO SPECIFY

Follow our guide and customize our products to suit your space

- 1
- 2
- 3
- 4
- 5

Select Height: Chair or Stool

- 1
- 2
- 3
- 4
- 5

Select Frame:



Swivel 4-star with casters

Wire

- 1
- 2
- 3
- 4
- 5

Select Frame Finish: Choose from selected frame finishes

Era Swivel 4-star  
Metal frame finish



Black

Era Wire  
RAL metal frame finish



Black 9005

- 1
- 2
- 3
- 4
- 5

Select Fabric: Available in fabric grades 1-8

Fabrics  
See pages 406-415

- 1
- 2
- 3
- 4
- 5

Select Accessories:

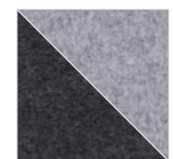

Two-tone fabric choice (Price at next fabric band)



Castors Matches the frame finish



**Era Swivel 4-star**  
width 23, depth 23, height 31.5, seat height 18"

FABRIC	ORDER CODE	PRICE
		Black Frame
1	ERC.S4S.FBB	\$1,635
2	ERC.S4S.FBC	\$1,707
3	ERC.S4S.FBD	\$1,787
4	ERC.S4S.FBE	\$1,895
5	ERC.S4S.FBF	\$2,015
6	ERC.S4S.FBG	\$2,238
7	ERC.S4S.FBH	\$2,463
8	ERC.S4S.FBI	\$2,696



**Era Swivel 4-star & castors**  
width 23, depth 23, height 32.5, seat height 19"

FABRIC	ORDER CODE	PRICE
1	ERC.S4C.FBB	\$1,764
2	ERC.S4C.FBC	\$1,838
3	ERC.S4C.FBD	\$1,918
4	ERC.S4C.FBE	\$2,031
5	ERC.S4C.FBF	\$2,144
6	ERC.S4C.FBG	\$2,374
7	ERC.S4C.FBH	\$2,599
8	ERC.S4C.FBI	\$2,824



**Era Wire**  
width 23, depth 23, height 31.5, seat height 18"

FABRIC	ORDER CODE	PRICE
1	ERC.WRE.FBB	\$1,536
2	ERC.WRE.FBC	\$1,603
3	ERC.WRE.FBD	\$1,681
4	ERC.WRE.FBE	\$1,787
5	ERC.WRE.FBF	\$1,891
6	ERC.WRE.FBG	\$2,102
7	ERC.WRE.FBH	\$2,314
8	ERC.WRE.FBI	\$2,525



**Era Stool Wire (No-back)**  
width 19, depth 18, height 30.5"

FABRIC	ORDER CODE	PRICE
1	ERS.WRE.SNB.FBB	\$1,346
2	ERS.WRE.SNB.FBC	\$1,392
3	ERS.WRE.SNB.FBD	\$1,431
4	ERS.WRE.SNB.FBE	\$1,486
5	ERS.WRE.SNB.FBF	\$1,543
6	ERS.WRE.SNB.FBG	\$1,663
7	ERS.WRE.SNB.FBH	\$1,783
8	ERS.WRE.SNB.FBI	\$1,895

# DOWNTOWN

---

Compact in size yet generous in seat - Downtown brings character and softness to any interior. It works equally well as a meeting chair or within breakout spaces.



## FEATURES

---

- Durable injection moulded foam construction
- Wide choice of frame styles and finishes
- Available with castors for mobility
- Extensive range of fabrics
- Compact



STEPS TO SPECIFY

Follow our guide and customize our products to suit your space

- ① ② ③ ④

Select Frame:



Swivel 4-star      4 Leg      Swivel 4-star & castors

- ① ② ③ ④

Select Frame Finish: Choose from selected frame finishes



- ① ② ③ ④

Select Fabric: Available in fabric grades 1-8 & leather 1-3

Fabrics  
See pages 406-415

- ① ② ③ ④

Select Accessories:

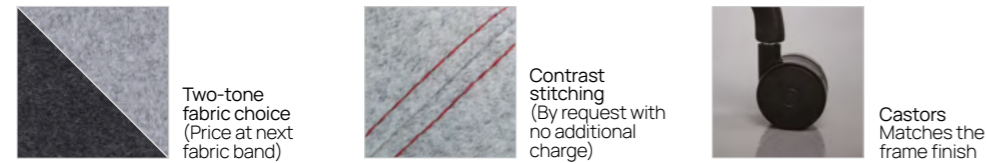

**Downtown Swivel 4-star**  
width 23, depth 23, height 32.5, seat height 18"

FABRIC	ORDER CODE	PRICE
		Black Frame
1	DTC.S4S.FBB	\$1,888
2	DTC.S4S.FBC	\$1,962
3	DTC.S4S.FBD	\$2,023
4	DTC.S4S.FBE	\$2,117
5	DTC.S4S.FBF	\$2,220
6	DTC.S4S.FBG	\$2,410
7	DTC.S4S.FBH	\$2,609
8	DTC.S4S.FBI	\$2,799



**Downtown Swivel 4-star & castors**  
width 23, depth 23, height 32.5, seat height 18"

FABRIC	ORDER CODE	PRICE
		Black Frame
1	DTC.S4C.FBB	\$2,052
2	DTC.S4C.FBC	\$2,113
3	DTC.S4C.FBD	\$2,178
4	DTC.S4C.FBE	\$2,281
5	DTC.S4C.FBF	\$2,377
6	DTC.S4C.FBG	\$2,574
7	DTC.S4C.FBH	\$2,773
8	DTC.S4C.FBI	\$2,965



**Downtown 4 Leg**  
width 23, depth 23, height 32.5, seat height 18"

FABRIC	ORDER CODE	PRICE
1	DTC.4W1.FBB	\$2,137
2	DTC.4W1.FBC	\$2,205
3	DTC.4W1.FBD	\$2,277
4	DTC.4W1.FBE	\$2,377
5	DTC.4W1.FBF	\$2,480
6	DTC.4W1.FBG	\$2,720
7	DTC.4W1.FBH	\$2,827
8	DTC.4W1.FBI	\$3,101
LEATHER		PRICE
L1	DTC.4W1.FBL1	\$-
L2	DTC.4W1.FBL2	\$-
L3	DTC.4W1.FBL3	\$-

# JIG SOFA

---

The Jig Sofa is part of an extensive family of products, built-to-last and particularly well-suited to high traffic areas. Available as both high and low, the high-backs promote semi-private areas for meetings or allow for focused working. The ability to contrast the button detail allows you to add complementary colors to the scheme.



## FEATURES

---

- Solid oak frame suitable for high traffic areas
- Deep foam, webbed seat for extra comfort
- Extensive range of fabrics with option of contrasting buttons
- High and low-back versions available

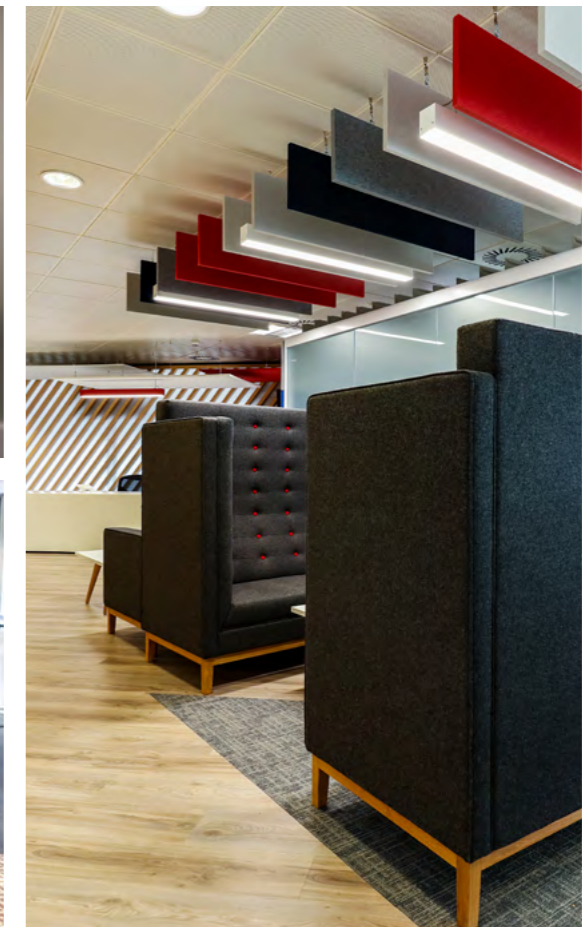

STEPS TO SPECIFY

Follow our guide and customize our products to suit your space

- 1
- 2
- 3
- 4
- 5

Select Height: High or Low

- 1
- 2
- 3
- 4
- 5

Select Size: Single, Two or Three Seater

- 1
- 2
- 3
- 4
- 5

Select Frame Finish:

Wood frame finishes

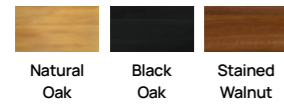

- 1
- 2
- 3
- 4
- 5

Select Fabric: Available in fabric grades 1-8 & leather 1-3

Fabrics  
See pages 406-415

- 1
- 2
- 3
- 4
- 5

Select Accessories:

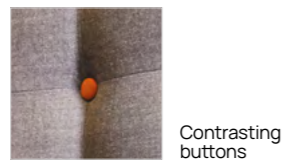
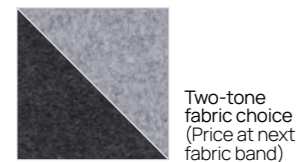

The Peggy Laptop Table is the perfect supplementary product and is available as an accessory at a reduced price of \$909. See page 296 for more information.



All buttons will be matching fabric unless specifically requested. No up-charge for contrasting buttons from the same fabric range. For more information on Accessories, see page 366.



**Jig Sofa Single Seater**  
width 41, depth 30, height 32.5, seat height 17"

FABRIC	ORDER CODE	PRICE
1	JF1S.LHT.FBB	\$5,713
2	JF1S.LHT.FBC	\$5,997
3	JF1S.LHT.FBD	\$6,282
4	JF1S.LHT.FBE	\$6,717
5	JF1S.LHT.FBF	\$7,146
6	JF1S.LHT.FBG	\$8,009
7	JF1S.LHT.FBH	\$8,864
8	JF1S.LHT.FBI	\$9,725



**Jig Sofa Two Seater**  
width 60, depth 30, height 32.5, seat height 17"

FABRIC	ORDER CODE	PRICE
1	JF2S.LHT.FBB	\$6,941
2	JF2S.LHT.FBC	\$7,297
3	JF2S.LHT.FBD	\$7,651
4	JF2S.LHT.FBE	\$8,179
5	JF2S.LHT.FBF	\$8,704
6	JF2S.LHT.FBG	\$9,766
7	JF2S.LHT.FBH	\$10,826
8	JF2S.LHT.FBI	\$11,880



**Jig Sofa Three Seater**  
width 78.5, depth 30, height 32.5, seat height 17"

FABRIC	ORDER CODE	PRICE
1	JF3S.LHT.FBB	\$8,421
2	JF3S.LHT.FBC	\$8,839
3	JF3S.LHT.FBD	\$9,255
4	JF3S.LHT.FBE	\$9,886
5	JF3S.LHT.FBF	\$10,511
6	JF3S.LHT.FBG	\$11,768
7	JF3S.LHT.FBH	\$13,029
8	JF3S.LHT.FBI	\$14,279



**Jig Sofa High Single Seater**  
width 41, depth 30, height 58, seat height 17"

FABRIC	ORDER CODE	PRICE
1	JF1S.HHT.FBB	\$7,435
2	JF1S.HHT.FBC	\$7,893
3	JF1S.HHT.FBD	\$8,346
4	JF1S.HHT.FBE	\$9,038
5	JF1S.HHT.FBF	\$9,725
6	JF1S.HHT.FBG	\$11,101
7	JF1S.HHT.FBH	\$12,480
8	JF1S.HHT.FBI	\$13,852



**Jig Sofa High Two Seater**  
width 60, depth 30, height 58, seat height 17"

FABRIC	ORDER CODE	PRICE
1	JF2S.HHT.FBB	\$9,247
2	JF2S.HHT.FBC	\$9,772
3	JF2S.HHT.FBD	\$10,294
4	JF2S.HHT.FBE	\$11,081
5	JF2S.HHT.FBF	\$11,861
6	JF2S.HHT.FBG	\$13,438
7	JF2S.HHT.FBH	\$15,008
8	JF2S.HHT.FBI	\$16,585



**Jig Sofa High Three Seater**  
width 78.5, depth 30, height 58, seat height 17"

FABRIC	ORDER CODE	PRICE
1	JF3S.HHT.FBB	\$10,872
2	JF3S.HHT.FBC	\$11,453
3	JF3S.HHT.FBD	\$12,041
4	JF3S.HHT.FBE	\$12,915
5	JF3S.HHT.FBF	\$13,790
6	JF3S.HHT.FBG	\$15,535
7	JF3S.HHT.FBH	\$17,289
8	JF3S.HHT.FBI	\$19,036

# JIG MODULAR

---

This modular range has been designed to create a multitude of comfortable, relaxed and practical layouts.



## FEATURES

---

- Solid oak frame suitable for high traffic areas
- Deep foam, webbed seat for extra comfort
- Extensive range of fabrics with option of contrasting buttons
- Linking clips supplied as standard

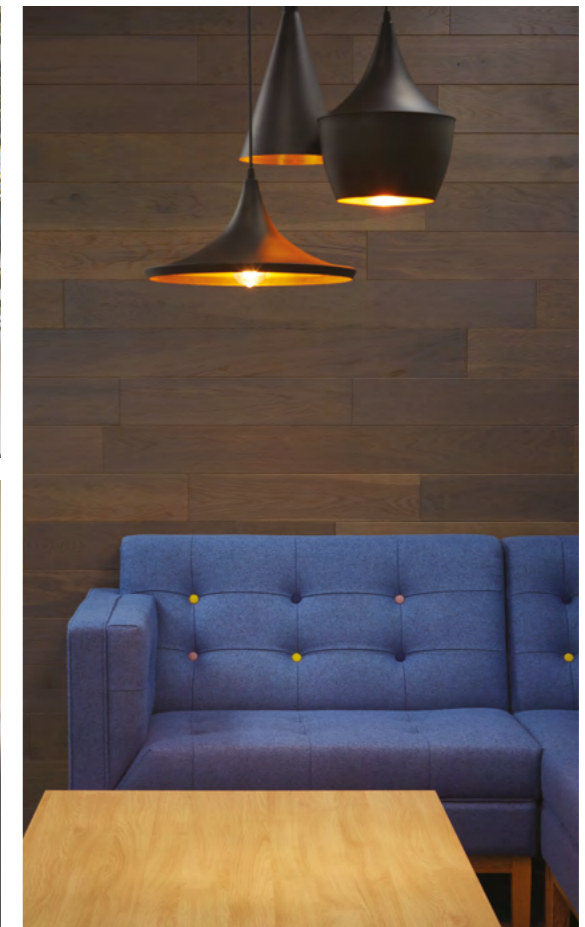

STEPS TO SPECIFY

Follow our guide and customize our products to suit your space

- 1
- 2
- 3
- 4

Select Configuration: Piece together modular units.  
Example configuration shown below



- 1
- 2
- 3
- 4

Select Frame Finish:

Wood frame finishes



Natural Oak    Black Oak    Stained Walnut

- 1
- 2
- 3
- 4

Choose Fabric: Available in fabric grades 1-8

Fabrics  
See pages 406-415

- 1
- 2
- 3
- 4

Select Accessories:

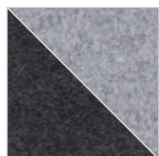

Two-tone fabric choice  
(Price at next fabric band)



Contrasting buttons



Peggy Laptop Table

The Peggy Laptop Table is the perfect supplementary product and is available as an accessory at a reduced price of \$909. See page 296 for more information.

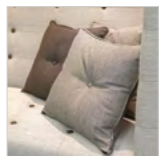

Cushions



Duet Power

All buttons will be matching fabric unless specifically requested. No up-charge for contrasting buttons from the same fabric range. For more information on Accessories, see page 366.



**Jig Modular Straight Unit**  
width 41, depth 30, height 32.5, seat height 17"

FABRIC	ORDER CODE	PRICE
1	JMSL.LHT.FBB	\$4,854
2	JMSL.LHT.FBC	\$5,053
3	JMSL.LHT.FBD	\$5,252
4	JMSL.LHT.FBE	\$5,552
5	JMSL.LHT.FBF	\$5,846
6	JMSL.LHT.FBG	\$6,436
7	JMSL.LHT.FBH	\$7,034
8	JMSL.LHT.FBI	\$7,626



**Jig Modular Corner Unit**  
width 30, depth 30, height 32.5, seat height 17"

FABRIC	ORDER CODE	PRICE
1	JMCL.LHT.FBB	\$5,724
2	JMCL.LHT.FBC	\$5,924
3	JMCL.LHT.FBD	\$6,119
4	JMCL.LHT.FBE	\$6,417
5	JMCL.LHT.FBF	\$6,711
6	JMCL.LHT.FBG	\$7,309
7	JMCL.LHT.FBH	\$7,901
8	JMCL.LHT.FBI	\$8,495



**Jig Modular End Left**  
width 41, depth 30, height 32.5, seat height 17"

FABRIC	ORDER CODE	PRICE
1	JMLL.LHT.FBB	\$5,877
2	JMLL.LHT.FBC	\$6,158
3	JMLL.LHT.FBD	\$6,444
4	JMLL.LHT.FBE	\$6,877
5	JMLL.LHT.FBF	\$7,305
6	JMLL.LHT.FBG	\$8,160
7	JMLL.LHT.FBH	\$9,017
8	JMLL.LHT.FBI	\$9,876



**Jig Modular End Right**  
width 41, depth 30, height 32.5, seat height 17"

FABRIC	ORDER CODE	PRICE
1	JMRL.LHT.FBB	\$5,877
2	JMRL.LHT.FBC	\$6,158
3	JMRL.LHT.FBD	\$6,444
4	JMRL.LHT.FBE	\$6,877
5	JMRL.LHT.FBF	\$7,305
6	JMRL.LHT.FBG	\$8,160
7	JMRL.LHT.FBH	\$9,017
8	JMRL.LHT.FBI	\$9,876



**Jig Modular Coffee Table (Upholstered)**  
width 30/41, depth 30, height 13"

FABRIC	Square		Rectangular	
	ORDER CODE	PRICE	ORDER CODE	PRICE
1	JMCS.FBB	\$3,279	JMCR.FBB	\$3,683
2	JMCS.FBC	\$3,320	JMCR.FBC	\$3,720
3	JMCS.FBD	\$3,364	JMCR.FBD	\$3,759
4	JMCS.FBE	\$3,428	JMCR.FBE	\$3,827
5	JMCS.FBF	\$3,490	JMCR.FBF	\$3,887
6	JMCS.FBG	\$3,616	JMCR.FBG	\$4,016
7	JMCS.FBH	\$3,745	JMCR.FBH	\$4,142
8	JMCS.FBI	\$3,871	JMCR.FBI	\$4,270



**Jig Modular Ottoman**  
width 41, depth 30, height 16.5, seat height 17"

FABRIC	ORDER CODE	PRICE
1	JMOT.FBB	\$4,032
2	JMOT.FBC	\$4,140
3	JMOT.FBD	\$4,254
4	JMOT.FBE	\$4,415
5	JMOT.FBF	\$4,581
6	JMOT.FBG	\$4,912
7	JMOT.FBH	\$5,241
8	JMOT.FBI	\$5,570

As standard, table tops are MFC in matching colors to the frames - Natural Oak frame with Oak top, Black Oak frame with Rustic Black Oak top and Walnut frame with Walnut top. All buttons will be matching fabric unless specifically requested. No up-charge for contrasting buttons from the same fabric range.

# HUDDLE MODULAR

---

A versatile modular system and available in two heights, Huddle can be arranged and linked into a variety of configurations, offering effective screening from walkways and adjacent areas. It works well within confined spaces, large open-plan areas and vast atriums.



## FEATURES

---

- Simple configuration
- Deep-foamed seat and back rests for maximum comfort
- Linking clips supplied as standard
- Extensive range of fabrics available
- Available in low or high heights





## STEPS TO SPECIFY

Follow our guide and customize our products to suit your space



Select Height: Low or High



Select Configuration: Piece together modular units.  
Example configurations shown below



Select Frame Finish: Chrome or Black Feet



Chrome



Black



Solid Oak



Choose Fabric: Available in fabric grades 1-8

Fabrics  
See pages 406-415



Select Accessories:

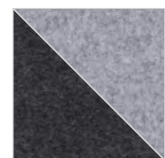

Two-tone fabric choice  
(Price at next fabric band)



Duet Power



Peggy Laptop Table

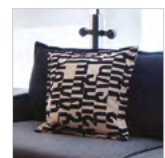

Cushions

The Peggy Laptop Table is the perfect supplementary product and is available as an accessory at a reduced price of \$909. See page 296 for more information.

For more information on Accessories, see page 366.





**Huddle Modular Low Single**  
width 25.5, depth 30, height 31,  
seat height 17.5"

FABRIC	ORDER CODE	PRICE
1	HMSL.LHT.FBB	\$2,907
2	HMSL.LHT.FBC	\$3,071
3	HMSL.LHT.FBD	\$3,243
4	HMSL.LHT.FBE	\$3,494
5	HMSL.LHT.FBF	\$3,754
6	HMSL.LHT.FBG	\$4,260
7	HMSL.LHT.FBH	\$4,766
8	HMSL.LHT.FBI	\$5,279



**Huddle Modular Low Double**  
width 51, depth 30, height 31,  
seat height 17.5"

FABRIC	ORDER CODE	PRICE
1	HMDL.LHT.FBB	\$3,726
2	HMDL.LHT.FBC	\$3,933
3	HMDL.LHT.FBD	\$4,140
4	HMDL.LHT.FBE	\$4,453
5	HMDL.LHT.FBF	\$4,761
6	HMDL.LHT.FBG	\$5,382
7	HMDL.LHT.FBH	\$6,005
8	HMDL.LHT.FBI	\$6,622



**Huddle Modular Low End Left**  
width 27, depth 30, height 31,  
seat height 17.5"

FABRIC	ORDER CODE	PRICE
1	HMLL.LHT.FBB	\$3,777
2	HMLL.LHT.FBC	\$3,981
3	HMLL.LHT.FBD	\$4,188
4	HMLL.LHT.FBE	\$4,501
5	HMLL.LHT.FBF	\$4,812
6	HMLL.LHT.FBG	\$5,435
7	HMLL.LHT.FBH	\$6,058
8	HMLL.LHT.FBI	\$6,679



**Huddle Modular Low End Right**  
width 27, depth 30, height 31,  
seat height 17.5"

FABRIC	ORDER CODE	PRICE
1	HMRL.LHT.FBB	\$3,777
2	HMRL.LHT.FBC	\$3,981
3	HMRL.LHT.FBD	\$4,188
4	HMRL.LHT.FBE	\$4,501
5	HMRL.LHT.FBF	\$4,812
6	HMRL.LHT.FBG	\$5,435
7	HMRL.LHT.FBH	\$6,058
8	HMRL.LHT.FBI	\$6,679



**Huddle Modular Low Corner 90°**  
width 30, depth 30, height 31,  
seat height 17.5"

FABRIC	ORDER CODE	PRICE
1	HMCL.LHT.FBB	\$3,616
2	HMCL.LHT.FBC	\$3,825
3	HMCL.LHT.FBD	\$4,034
4	HMCL.LHT.FBE	\$4,342
5	HMCL.LHT.FBF	\$4,655
6	HMCL.LHT.FBG	\$5,272
7	HMCL.LHT.FBH	\$5,893
8	HMCL.LHT.FBI	\$6,516



**Huddle Modular Low 45° Bend**  
width 40, depth 30, height 31,  
seat height 17.5"

FABRIC	ORDER CODE	PRICE
1	HM45L.LHT.FBB	\$3,848
2	HM45L.LHT.FBC	\$4,050
3	HM45L.LHT.FBD	\$4,269
4	HM45L.LHT.FBE	\$4,572
5	HM45L.LHT.FBF	\$4,883
6	HM45L.LHT.FBG	\$5,502
7	HM45L.LHT.FBH	\$6,127
8	HM45L.LHT.FBI	\$6,741



**Huddle Modular Low 30° Bend**  
width 40, depth 30, height 31,  
seat height 17.5"

FABRIC	ORDER CODE	PRICE
1	HM30L.LHT.FBB	\$3,761
2	HM30L.LHT.FBC	\$3,965
3	HM30L.LHT.FBD	\$4,172
4	HM30L.LHT.FBE	\$4,480
5	HM30L.LHT.FBF	\$4,793
6	HM30L.LHT.FBG	\$5,417
7	HM30L.LHT.FBH	\$6,035
8	HM30L.LHT.FBI	\$6,654



**Huddle Modular High Single**  
width 25.5, depth 30, height 58.5,  
seat height 17.5"

FABRIC	ORDER CODE	PRICE
1	HMSL.HHT.FBB	\$4,561
2	HMSL.HHT.FBC	\$4,814
3	HMSL.HHT.FBD	\$5,065
4	HMSL.HHT.FBE	\$5,451
5	HMSL.HHT.FBF	\$5,833
6	HMSL.HHT.FBG	\$6,596
7	HMSL.HHT.FBH	\$7,360
8	HMSL.HHT.FBI	\$8,121



**Huddle Modular High Double**  
width 51, depth 30, height 58.5,  
seat height 17.5"

FABRIC	ORDER CODE	PRICE
1	HMDL.HHT.FBB	\$6,327
2	HMDL.HHT.FBC	\$6,684
3	HMDL.HHT.FBD	\$7,038
4	HMDL.HHT.FBE	\$7,569
5	HMDL.HHT.FBF	\$8,110
6	HMDL.HHT.FBG	\$9,170
7	HMDL.HHT.FBH	\$10,242
8	HMDL.HHT.FBI	\$11,309



**Huddle Modular High End Left**  
width 27, depth 30, height 58.5,  
seat height 17.5"

FABRIC	ORDER CODE	PRICE
1	HMLL.HHT.FBB	\$5,184
2	HMLL.HHT.FBC	\$5,591
3	HMLL.HHT.FBD	\$6,001
4	HMLL.HHT.FBE	\$6,608
5	HMLL.HHT.FBF	\$7,217
6	HMLL.HHT.FBG	\$8,441
7	HMLL.HHT.FBH	\$9,658
8	HMLL.HHT.FBI	\$10,881



**Huddle Modular High End Right**  
width 27, depth 30, height 58.5,  
seat height 17.5"

FABRIC	ORDER CODE	PRICE
1	HMRL.HHT.FBB	\$5,184
2	HMRL.HHT.FBC	\$5,591
3	HMRL.HHT.FBD	\$6,001
4	HMRL.HHT.FBE	\$6,608
5	HMRL.HHT.FBF	\$7,217
6	HMRL.HHT.FBG	\$8,441
7	HMRL.HHT.FBH	\$9,658
8	HMRL.HHT.FBI	\$10,881



**Huddle Modular High Corner 90°**  
width 30, depth 30, height 58.5,  
seat height 17.5"

FABRIC	ORDER CODE	PRICE
1	HMCL.HHT.FBB	\$6,017
2	HMCL.HHT.FBC	\$6,320
3	HMCL.HHT.FBD	\$6,622
4	HMCL.HHT.FBE	\$7,086
5	HMCL.HHT.FBF	\$7,539
6	HMCL.HHT.FBG	\$8,455
7	HMCL.HHT.FBH	\$9,370
8	HMCL.HHT.FBI	\$10,286



**Huddle Modular High 45° Bend**  
width 40, depth 30, height 58.5,  
seat height 17.5"

FABRIC	ORDER CODE	PRICE
1	HM45L.HHT.FBB	\$5,506
2	HM45L.HHT.FBC	\$5,810
3	HM45L.HHT.FBD	\$6,120
4	HM45L.HHT.FBE	\$6,580
5	HM45L.HHT.FBF	\$7,033
6	HM45L.HHT.FBG	\$7,947
7	HM45L.HHT.FBH	\$8,862
8	HM45L.HHT.FBI	\$9,780



**Huddle Modular High 30° Bend**  
width 40, depth 30, height 58.5,  
seat height 17.5"

FABRIC	ORDER CODE	PRICE
1	HM30L.HHT.FBB	\$5,444
2	HM30L.HHT.FBC	\$5,755
3	HM30L.HHT.FBD	\$6,058
4	HM30L.HHT.FBE	\$6,516
5	HM30L.HHT.FBF	\$6,974
6	HM30L.HHT.FBG	\$7,884
7	HM30L.HHT.FBH	\$8,800
8	HM30L.HHT.FBI	\$9,718

# DRUM

This versatile fully upholstered stool is lightweight and manoeuvrable. A fun and practical seating solution enabling spontaneous meetings. Available with castors for added flexibility to move around the workplace. Drum can be used in every conceivable environment.



## FEATURES

- Extensive range of fabrics
- Easy to reposition and transport
- Available with or without castors

## STEPS TO SPECIFY

Follow our guide and customize our products to suit your space

1 2

Select Base: With or without castors



### Drum

diameter 16.5, height 18/19"

1 2

Choose Fabric: Available in fabric grades 1-8

Fabrics  
See pages 406-415

FABRIC	ORDER CODE	PRICE	ORDER CODE	PRICE
	Without castors		With castors	
1	DMS.NCA.FBB	\$619	DMS.WCA.FBB	\$768
2	DMS.NCA.FBC	\$667	DMS.WCA.FBC	\$814
3	DMS.NCA.FBD	\$715	DMS.WCA.FBD	\$860
4	DMS.NCA.FBE	\$787	DMS.WCA.FBE	\$934
5	DMS.NCA.FBF	\$856	DMS.WCA.FBF	\$1,001
6	DMS.NCA.FBG	\$994	DMS.WCA.FBG	\$1,143
7	DMS.NCA.FBH	\$1,136	DMS.WCA.FBH	\$1,283
8	DMS.NCA.FBI	\$1,279	DMS.WCA.FBI	\$1,426

## Seating - Chairs & Stools

BLUME CHAIR & STOOL	220
EGO	246
GROW STOOL	252
ORA	228
RELIC BENCH & STOOL	242
SCANDI CHAIR & STOOL	234
SWING	224
TIPSY STOOL	232
VECK	238
WISH	216



# WISH

---

Wish was developed to pay homage to Scandinavian chair profiles of the 1940s. Each considered detail has been designed with a nod to Scandinavian design heritage that creates a refined, yet elegant silhouette, with oval frame profile for enhanced comfort.



## FEATURES

---

Timeless design with recognition of Scandinavian design heritage

Available with wood and upholstered seat options

Curved black steel frame

Versatile for contract and hospitality

Black frame finish

Quick Ship available on selected variations and finishes, see pages 12 - 17 for more information.



## STEPS TO SPECIFY

Follow our guide and customize our products to suit your space

1 2 3

Select Seat Type: Wood or Upholstered



1 2 3

Select Frame Finish: Black frame finish only

RAL metal frame finish



Black  
9005

1 2 3

Select Seat Finish and Fabric: (if applicable) Choose from selected finishes

Wood veneer finishes



Natural Oak    Black Stained Ash

Wish Upholstered: Black Stained Ash seat veneer as standard.  
Available in fabric grades 1-8 & leather 1-3

Fabrics  
See pages 406-415



**Wish Chair**  
width 22, depth 22.5, height 30, seat height 17.5"

SEAT FINISH	ORDER CODE	PRICE
Wood Veneer		
Oak Veneer	WSC.BK.ST/NOK	\$1,286
Black Oak Veneer	WSC.BK.ST/BKA	\$1,286



**Wish Upholstered Chair**  
width 22, depth 22.5, height 30, seat height 18.5"

FABRIC	ORDER CODE	PRICE
	Black Oak Veneer	
1	WSC.BK.WSP.FBB	\$1,585
2	WSC.BK.WSP.FBC	\$1,612
3	WSC.BK.WSP.FBD	\$1,633
4	WSC.BK.WSP.FBE	\$1,654
5	WSC.BK.WSP.FBF	\$1,686
6	WSC.BK.WSP.FBG	\$1,750
7	WSC.BK.WSP.FBH	\$1,815
8	WSC.BK.WSP.FBI	\$1,877



# BLUME

---

A contemporary styled range of chairs and stools, the Blume range combines stunning aesthetics with real world functional design details. With sustainability at the core of our business, for every Blume purchased a tree gets planted!



## FEATURES

---

- For every purchase, a tree gets planted
- Ergonomic back design
- Crafted solid natural ash or metal frame
- Available as a chair or a stool
- Available in our curated range of fabrics



STEPS TO SPECIFY

Follow our guide and customize our products to suit your space

- 1
- 2
- 3
- 4

Select Height: Chair or Stool

- 1
- 2
- 3
- 4

Select Frame:



4 Leg  
(Wooden frame)

4 Leg  
(Steel frame)

- 1
- 2
- 3
- 4

Select Frame Finish: Choose from selected frame finishes

Blume 4 Leg (Wooden frame)

Wood frame finishes



Oak  
(Stained  
Ash)    Black Ash    Natural Ash

Blume 4 Leg

RAL metal frame finishes



Black  
9005

- 1
- 2
- 3
- 4

Select Fabric: Available in limited selected fabrics

Camira - Synergy / Mainline Flax / Blazer

Kvadrat - Remix 3

Other Fabrics - POA

Fabrics

See pages 406-415



**Blume 4 Leg**  
width 23.5, depth 21.5, height 33.5, seat height 18.5"

FABRIC	ORDER CODE	PRICE
1	BMC.4L1.BK.FBB	\$1,067
2	BMC.4L1.BK.FBC	\$1,109

Other Fabric Bands - POA



**Blume Stool 4 Leg**  
width 22.5, depth 24, height 40, seat height 29"

FABRIC	ORDER CODE	PRICE
1	BMS.4L1.BK.FBB	\$1,408
2	BMS.4L1.BK.FBC	\$1,454

Other Fabric Bands - POA



**Blume 4 Leg (Wooden frame)**  
width 20, depth 19.5, height 33.5, seat height 18.5"

FABRIC	ORDER CODE	PRICE
	Oak (Stained Ash)    Black Ash    Natural Ash	
1	BMC.4W1.OCA.FBB    BMC.4W1.SBA.FBB    BMC.4W1.NAS.FBB	\$1,801
2	BMC.4W1.OCA.FBC    BMC.4W1.SBA.FBC    BMC.4W1.NAS.FBC	\$1,842

Other Fabric Bands - POA



**Blume Stool 4 Leg (Wooden frame)**  
width 19.5, depth 19.5, height 40.5, seat height 29.5"

FABRIC	ORDER CODE	PRICE
	Oak (Stained Ash)    Black Ash    Natural Ash	
1	BMS.4W1.OCA.FBB    BMS.4W1.SBA.FBB    BMS.4W1.NAS.FBB	\$2,130
2	BMS.4W1.OCA.FBC    BMS.4W1.SBA.FBC    BMS.4W1.NAS.FBC	\$2,174

Other Fabric Bands - POA



# SWING

---

Swing is perfect for a range of uses and environments, with a compact footprint that offers a comfortable yet practical seating solution. Available in chair or stool height and with a choice of RAL colored frame finishes, Swing offers a timeless look to complement any collaboration or breakout space.

## FEATURES

---

Natural or Black Oak suspended seat design

Lightweight and compact design

Unique continuous sled frame

Available as a chair or a stool

Wide choice of frame finishes available

Chairs stackable up to 3 high

Stools stackable up to 2 high



## STEPS TO SPECIFY

Follow our guide and customize our products to suit your space

1 2 3

Select Height: Chair or Stool

1 2 3

Select Seat Finish: Choose from selected finishes

Wood veneer finishes

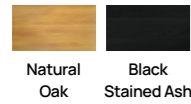

1 2 3

Select Frame Finish: Choose from selected frame finishes. Black as standard. RAL is an upcharge

RAL metal frame finishes

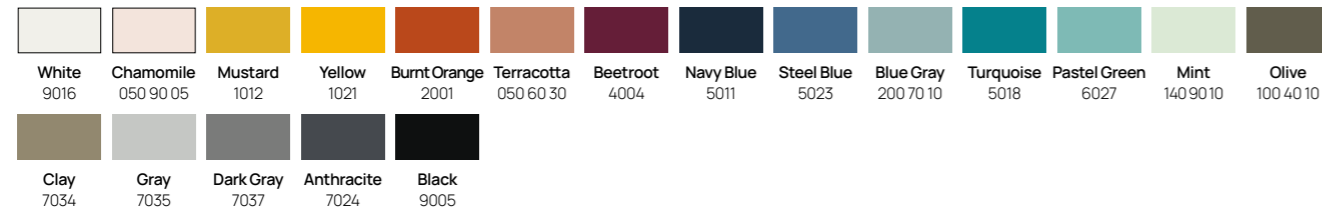

**Swing Chair**  
width 20, depth 20, height 30.5, seat height 18.5"

SEAT FINISH	ORDER CODE	PRICE	
Wood Veneer		Black	Other RAL
Natural Oak	SWC.ST/NOK	\$856	\$973
Black Stained Ash	SWC.ST/BKA	\$856	\$973



**Swing Stool**  
width 20, depth 21.5, height 38, seat height 28.5"

SEAT FINISH	ORDER CODE	PRICE	
Wood Veneer		Black	Other RAL
Natural Oak	SWS.ST/NOK	\$945	\$1,106
Black Stained Ash	SWS.ST/BKA	\$945	\$1,106

\*counterheight available upon request



# ORA

---

Organically shaped, this compact meeting chair is both lightweight and comfortable. With a timeless form and the option of steel or timber frames. Ora is an easy way to introduce elegance into your workspace.



## FEATURES

---

- Compact design
- Upholstered or polypropylene seats
- Wide choice of frame finishes available
- Castors for mobility on specific bases



STEPS TO SPECIFY

Follow our guide and customize our products to suit your space

- 1
- 2
- 3
- 4

Select Seat Shell: Upholstered or Polypropylene seat



**Ora 4 Leg**  
width 20, depth 20.5, height 31.5,  
seat height 17.5"



**Ora Swivel 4-star**  
width 20, depth 20.5, height 31.5,  
seat height 17.5"



**Ora Swivel 4-star & castors**  
width 20, depth 20.5, height 31.5,  
seat height 17.5"



**Ora 4 Leg (Wooden frame)**  
width 20, depth 20.5, height 31.5,  
seat height 17.5"

- 1
- 2
- 3
- 4

Select Frame:



FINISH	ORDER CODE	PRICE	FINISH	ORDER CODE	PRICE	FINISH	ORDER CODE	PRICE	FINISH	ORDER CODE	PRICE
	RAL Frame			RAL Frame			RAL Frame			RAL Frame	
White	ORC.4L1.PWH	\$878	White	ORC.S4S.BK.PWH	\$948	White	ORC.S5C.WH	\$948	White	ORC.4W1.WH	\$1,165
Clay	ORC.4L1.PCY	\$878	Clay	ORC.S4S.BK.PCY	\$948	Clay	ORC.S5C.CY	\$948	Clay	ORC.4W1.PCY	\$1,165
Black	ORC.4L1.PBK	\$878	Black	ORC.S4S.BK.PBK	\$948	Black	ORC.S5C.BK	\$948	Black	ORC.4W1.PBK	\$1,165

- 1
- 2
- 3
- 4

Select Frame Finish: Choose from selected frame finishes

**Ora Swivel 4-star**  
Polypropylene frame finishes

**Ora 4 Leg (Wooden frame)**  
Wood frame finishes

Black, Natural Oak, Black Oak

**Ora 4 Leg**  
RAL metal frame finishes

White 9016	Chamomile 050 90 05	Mustard 1012	Yellow 1021	Burnt Orange 2001	Terracotta 050 60 30	Beetroot 4004	Navy Blue 5011	Steel Blue 5023	Blue Gray 200 70 10	Turquoise 5018	Pastel Green 6027	Mint 140 90 10	Olive 100 40 10
Clay 7034	Gray 7035	Dark Gray 7037	Anthracite 7024	Black 9005									



**Ora Upholstered 4 Leg**  
width 20, depth 20.5, height 31.5,  
seat height 17.5"



**Ora Upholstered Swivel 4-star**  
width 20, depth 20.5, height 31.5,  
seat height 17.5"



**Ora Upholstered Swivel 4-star & castors**  
width 20, depth 20.5, height 31.5,  
seat height 17.5"



**Ora Upholstered 4 Leg (Wooden frame)**  
width 20, depth 20.5, height 31.5,  
seat height 17.5"

FABRIC	ORDER CODE	PRICE	FABRIC	ORDER CODE	PRICE	FABRIC	ORDER CODE	PRICE	FABRIC	ORDER CODE	PRICE
	RAL Frame			RAL Frame			RAL Frame			RAL Frame	
1	ORC.4L1.UPH.FBB	\$1,644	1	ORC.S4S.BK.UPH.FBB	\$1,644	1	ORC.S5C.UPH.FBB	\$1,644	1	ORC.4W1.UPH.FBB	\$1,853
2	ORC.4L1.UPH.FBC	\$1,712	2	ORC.S4S.BK.UPH.FBC	\$1,712	2	ORC.S5C.UPH.FBC	\$1,712	2	ORC.4W1.UPH.FBC	\$1,919
3	ORC.4L1.UPH.FBD	\$1,774	3	ORC.S4S.BK.UPH.FBD	\$1,774	3	ORC.S5C.UPH.FBD	\$1,774	3	ORC.4W1.UPH.FBD	\$1,985
4	ORC.4L1.UPH.FBE	\$1,873	4	ORC.S4S.BK.UPH.FBE	\$1,873	4	ORC.S5C.UPH.FBE	\$1,873	4	ORC.4W1.UPH.FBE	\$2,082
5	ORC.4L1.UPH.FBF	\$1,973	5	ORC.S4S.BK.UPH.FBF	\$1,973	5	ORC.S5C.UPH.FBF	\$1,973	5	ORC.4W1.UPH.FBF	\$2,180
6	ORC.4L1.UPH.FBG	\$2,171	6	ORC.S4S.BK.UPH.FBG	\$2,171	6	ORC.S5C.UPH.FBG	\$2,171	6	ORC.4W1.UPH.FBG	\$2,376
7	ORC.4L1.UPH.FBH	\$2,368	7	ORC.S4S.BK.UPH.FBH	\$2,368	7	ORC.S5C.UPH.FBH	\$2,368	7	ORC.4W1.UPH.FBH	\$2,575
8	ORC.4L1.UPH.FBI	\$2,565	8	ORC.S4S.BK.UPH.FBI	\$2,565	8	ORC.S5C.UPH.FBI	\$2,565	8	ORC.4W1.UPH.FBI	\$2,770

- 1
- 2
- 3
- 4

Select Fabric: (if applicable) Available in fabric grades 1-8

Fabrics  
See pages 406-415

# TIPSY STOOL

Something a little different. A lightweight metal frame allows Tippy to be picked up and moved with ease. A comfortable fun stool that allows the user to create movement, Tippy has all the moves.



## FEATURES

- Dynamic stool allowing users to remain active
- Lightweight & easy to move
- Extensive range of fabrics available
- Wide range of frame RAL colors



## STEPS TO SPECIFY

Follow our guide and customize our products to suit your space

1 2

Select Frame Finish: Choose from selected frame finishes

RAL metal frame finishes



**Tippy Stool**  
diameter 17, height 20.5"

1 2

Select Seat Pad Fabric:

Available in fabric grades 1-8

Fabrics  
See pages 406-415



Upholstered  
Seat Pad

FABRIC	ORDER CODE	PRICE
1	TIPS.FBB	\$794
2	TIPS.FBC	\$809
3	TIPS.FBD	\$825
4	TIPS.FBE	\$848
5	TIPS.FBF	\$872
6	TIPS.FBG	\$915
7	TIPS.FBH	\$966
8	TIPS.FBI	\$1,011

# SCANDI CHAIR & STOOL

Fine details and profiled frames are elegantly crafted, with an optional seat pad for additional comfort. Available in Natural Oak or a range of colored finishes to suit any space. Timeless and elegant.



## FEATURES

- Wide choice of stained wood finishes available
- Slim back design
- Crafted solid natural oak or stained and lacquered ash frame
- Available as a chair or a stool
- Optional seat pad



STEPS TO SPECIFY

Follow our guide and customize our products to suit your space

1 2 3

Select Height: Chair or Stool

1 2 3

Select Finish: Choose from selected finishes

Wood finishes

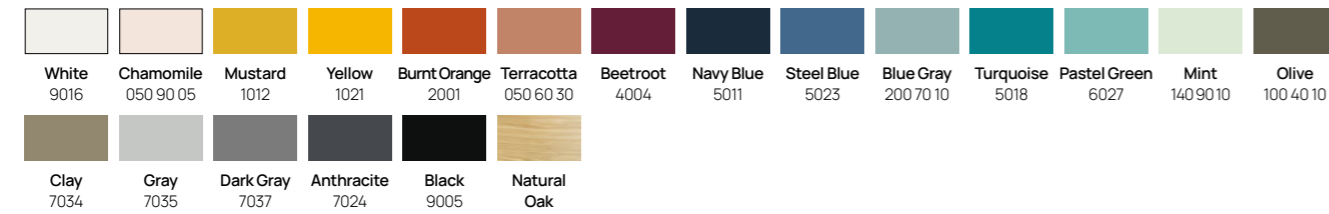

1 2 3

Select Accessories:



Upholstered Seat Pad

(Available in fabric grades 1-8)



Scandi Chair

width 20.5, depth 19.5, height 30.5, seat height 18.5"

DESCRIPTION	ORDER CODE	PRICE	
		Natural Oak	RAL Colored Stained Ash
Chair	SAC.NSP	\$1,146	\$1,236



Scandi Chair With Upholstered Seat Pad

width 20.5, depth 19.5, height 30.5, seat height 19.5"

FABRIC	ORDER CODE	PRICE	
		Natural Oak	RAL Colored Stained Ash
1	SAC.WSP.FBB	\$1,310	\$1,400
2	SAC.WSP.FBC	\$1,330	\$1,420
3	SAC.WSP.FBD	\$1,342	\$1,432
4	SAC.WSP.FBE	\$1,363	\$1,453
5	SAC.WSP.FBF	\$1,383	\$1,473
6	SAC.WSP.FBG	\$1,428	\$1,518
7	SAC.WSP.FBH	\$1,472	\$1,562
8	SAC.WSP.FBI	\$1,515	\$1,605



Scandi Stool

width 20, depth 16, height 39.5, seat height 30"

DESCRIPTION	ORDER CODE	PRICE	
		Natural Oak	RAL Colored Stained Ash
Stool	SAS.NSP	\$1,570	\$1,660



Scandi Stool With Upholstered Seat Pad

width 20, depth 16, height 39.5, seat height 31"

FABRIC	ORDER CODE	PRICE	
		Natural Oak	RAL Colored Stained Ash
1	SAS.WSP.FBB	\$1,734	\$1,824
2	SAS.WSP.FBC	\$1,754	\$1,844
3	SAS.WSP.FBD	\$1,766	\$1,856
4	SAS.WSP.FBE	\$1,787	\$1,877
5	SAS.WSP.FBF	\$1,807	\$1,897
6	SAS.WSP.FBG	\$1,852	\$1,942
7	SAS.WSP.FBH	\$1,896	\$1,986
8	SAS.WSP.FBI	\$1,939	\$2,029

# VECK

---

Veck is a versatile, lightweight tubular framed stool, with a unique triangular punched, patterned seat - perfect for use indoors or outdoors. Available as a High, Counter-height or Low Stool with metal, wood veneer and upholstered seat pad options.



## FEATURES

---

- Metal seat option suitable for indoor or outdoor use
- Available with metal, wood and upholstered seat options
- Wide choice of frame finishes available
- Available in 3 seat heights
- Stackable up to 4 high





STEPS TO SPECIFY

Follow our guide and customize our products to suit your space

- 1
- 2
- 3
- 4

Select Seat Type: Metal, Wood or Upholstered



- 1
- 2
- 3
- 4

Select Height: Low, Medium or High Stool

- 1
- 2
- 3
- 4

Select Seat Finish or Fabric: (if applicable) Choose from selected finishes

Veck Indoor Upholstered: Available in fabric grades 1-8

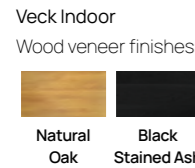

Fabrics  
See pages 406-415

- 1
- 2
- 3
- 4

Select Frame Finish: Choose from selected frame finishes

RAL metal frame finishes

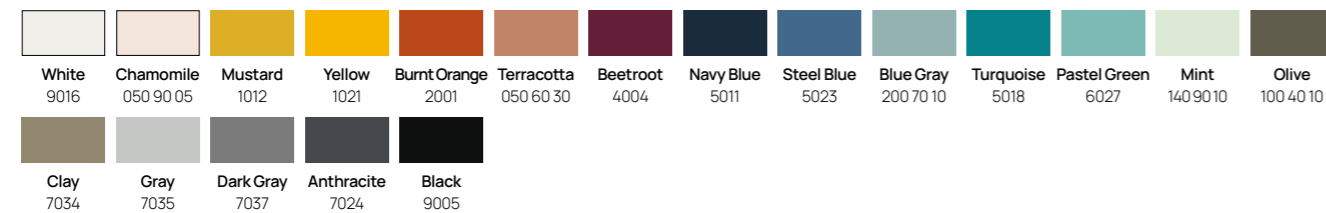

**Veck Low Stool**  
width 21.5, depth 22, height 22, seat height 18.5"

DESCRIPTION	ORDER CODE	PRICE
Metal	VKS.LHT	\$614



**Veck Medium Stool (Counter-height)**  
width 21.5, depth 22, height 29.5, seat height 25.5"

DESCRIPTION	ORDER CODE	PRICE
Metal	VKS.MHT	\$676



**Veck High Stool**  
width 21.5, depth 23, height 35, seat height 31"

DESCRIPTION	ORDER CODE	PRICE
Metal	VKS.HHT	\$716



**Veck Indoor Low Stool**  
width 21.5, depth 22, height 22, seat height 18.5"

SEAT FINISH	ORDER CODE	PRICE
Wood Veneer		
Natural Oak	VKS-I.LHT.ST/NOK	\$596
Black Stained Ash	VKS-I.LHT.ST/BOK	\$596



**Veck Indoor Medium Stool (Counter-height)**  
width 21.5, depth 22, height 29.5, seat height 25.5"

SEAT FINISH	ORDER CODE	PRICE
Wood Veneer		
Natural Oak	VKS-I.MHT.ST/NOK	\$628
Black Stained Ash	VKS-I.MHT.ST/BOK	\$628



**Veck Indoor High Stool**  
width 21.5, depth 23, height 35, seat height 31"

SEAT FINISH	ORDER CODE	PRICE
Wood Veneer		
Natural Oak	VKS-I.HHT.ST/NOK	\$653
Black Stained Ash	VKS-I.HHT.ST/BOK	\$653



**Veck Indoor Upholstered Low Stool**  
width 21.5, depth 22, height 22, seat height 18.5"

FABRIC	ORDER CODE	PRICE
1	VKS-I.LHT.WSP/U.FBB	\$760
2	VKS-I.LHT.WSP/U.FBC	\$776
3	VKS-I.LHT.WSP/U.FBD	\$800
4	VKS-I.LHT.WSP/U.FBE	\$829
5	VKS-I.LHT.WSP/U.FBF	\$860
6	VKS-I.LHT.WSP/U.FBG	\$925
7	VKS-I.LHT.WSP/U.FBH	\$987
8	VKS-I.LHT.WSP/U.FBI	\$1,050



**Veck Indoor Upholstered Medium Stool (Counter-height)**  
width 21.5, depth 22, height 29.5, seat height 25.5"

FABRIC	ORDER CODE	PRICE
1	VKS-I.MHT.WSP/U.FBB	\$790
2	VKS-I.MHT.WSP/U.FBC	\$809
3	VKS-I.MHT.WSP/U.FBD	\$831
4	VKS-I.MHT.WSP/U.FBE	\$860
5	VKS-I.MHT.WSP/U.FBF	\$895
6	VKS-I.MHT.WSP/U.FBG	\$960
7	VKS-I.MHT.WSP/U.FBH	\$1,019
8	VKS-I.MHT.WSP/U.FBI	\$1,081



**Veck Indoor Upholstered High Stool**  
width 21.5, depth 23, height 35, seat height 31"

FABRIC	ORDER CODE	PRICE
1	VKS-I.HHT.WSP/U.FBB	\$817
2	VKS-I.HHT.WSP/U.FBC	\$835
3	VKS-I.HHT.WSP/U.FBD	\$856
4	VKS-I.HHT.WSP/U.FBE	\$888
5	VKS-I.HHT.WSP/U.FBF	\$921
6	VKS-I.HHT.WSP/U.FBG	\$981
7	VKS-I.HHT.WSP/U.FBH	\$1,046
8	VKS-I.HHT.WSP/U.FBI	\$1,107

# RELIC BENCH & STOOL

---

This flexible range is a natural choice for any co-working environment. A fusion of rustic detail and industrial inspiration, the extensive range of finishes enables Relic to be used across every scheme.



## FEATURES

---

Wide range of frame finishes available

Extensive range of fabrics

Fast assembly



STEPS TO SPECIFY

Follow our guide and customize our products to suit your space

- 1
- 2
- 3
- 4

Select Product: Bench or Stool

- 1
- 2
- 3
- 4

Select Size

- 1
- 2
- 3
- 4

Select Frame Finish: RAL, Vintage or Raw Steel

RAL metal frame finishes

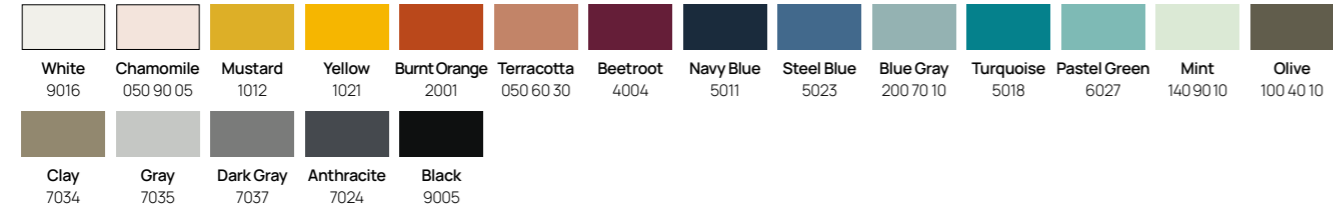

Vintage metal frame finishes

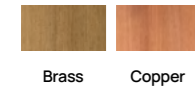

Metal frame finishes



- 1
- 2
- 3
- 4

Select Seat Pad Fabric: Available in fabric grades 1-8

Fabrics  
See pages 406-415



**Relic Low Stool (upholstered)**  
width 16, depth 15.5, height 18"

FABRIC	ORDER CODE	PRICE	
Upholstered			
	Frame Finish:	RAL/Raw	Vintage
1	RSS.U.LHT.40D.FBB	\$1,226	\$1,734
2	RSS.U.LHT.40D.FBC	\$1,251	\$1,755
3	RSS.U.LHT.40D.FBD	\$1,279	\$1,780
4	RSS.U.LHT.40D.FBE	\$1,323	\$1,819
5	RSS.U.LHT.40D.FBF	\$1,357	\$1,858
6	RSS.U.LHT.40D.FBG	\$1,435	\$1,934
7	RSS.U.LHT.40D.FBH	\$1,511	\$2,013
8	RSS.U.LHT.40D.FBI	\$1,589	\$2,088



**Relic High Stool (upholstered)**  
width 16, depth 15.5, height 30"

FABRIC	ORDER CODE	PRICE	
Upholstered			
	Frame Finish:	RAL/Raw	Vintage
1	RSS.U.HHT.40D.FBB	\$1,329	\$1,934
2	RSS.U.HHT.40D.FBC	\$1,355	\$1,964
3	RSS.U.HHT.40D.FBD	\$1,380	\$1,983
4	RSS.U.HHT.40D.FBE	\$1,424	\$2,022
5	RSS.U.HHT.40D.FBF	\$1,458	\$2,068
6	RSS.U.HHT.40D.FBG	\$1,539	\$2,141
7	RSS.U.HHT.40D.FBH	\$1,610	\$2,220
8	RSS.U.HHT.40D.FBI	\$1,691	\$2,295



**Relic Small Bench (upholstered)**  
width 39.5, depth 15.5, height 18"

FABRIC	ORDER CODE	PRICE	
Upholstered			
	Frame Finish:	RAL/Raw	Vintage
1	RSB.U.104R.FBB	\$2,378	\$2,893
2	RSB.U.104R.FBC	\$2,429	\$2,944
3	RSB.U.104R.FBD	\$2,479	\$2,997
4	RSB.U.104R.FBE	\$2,562	\$3,073
5	RSB.U.104R.FBF	\$2,638	\$3,156
6	RSB.U.104R.FBG	\$2,795	\$3,303
7	RSB.U.104R.FBH	\$2,944	\$3,462
8	RSB.U.104R.FBI	\$3,100	\$3,613



**Relic Medium Bench (upholstered)**  
width 63, depth 15.5, height 18"

FABRIC	ORDER CODE	PRICE	
Upholstered			
	Frame Finish:	RAL/Raw	Vintage
1	RSB.U.164R.FBB	\$2,744	\$3,264
2	RSB.U.164R.FBC	\$2,852	\$3,365
3	RSB.U.164R.FBD	\$2,956	\$3,471
4	RSB.U.164R.FBE	\$3,107	\$3,623
5	RSB.U.164R.FBF	\$3,264	\$3,779
6	RSB.U.164R.FBG	\$3,574	\$4,085
7	RSB.U.164R.FBH	\$3,885	\$4,395
8	RSB.U.164R.FBI	\$4,193	\$4,706

# EGO

---

Robust and durable; the Ego fuses reliability with craftsmanship. Its simple design and gentle curves make it an instant classic. Sleek metal legs offer an easy way to introduce a pop of color and elegance into your workspace.



## FEATURES

---

- Wide choice of frame finishes available
- 10 shell colors
- Upholstered seat pad option
- Sled and 4 Leg (Metal) are stackable
- Wipe clean

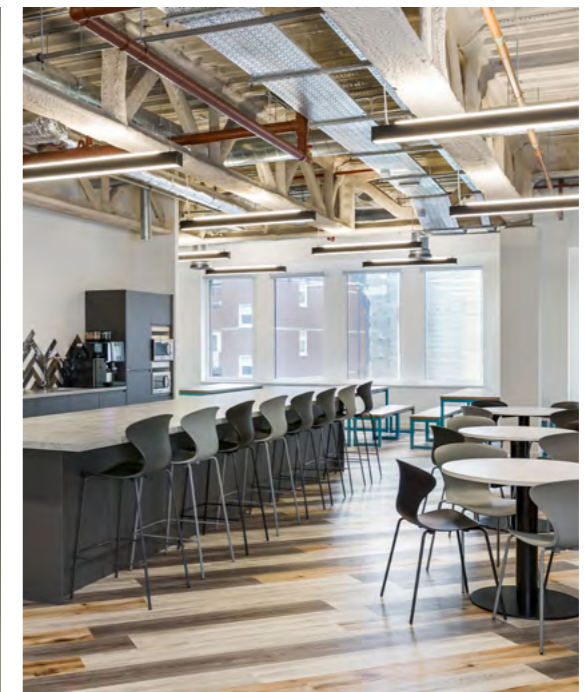

## STEPS TO SPECIFY

Follow our guide and customize our products to suit your space

1 2 3 4 5

Select Height: Chair or Stool

1 2 3 4 5

Select Seat Shell Color:



1 2 3 4 5

Select Frame:



4 Leg

Sled

1 2 3 4 5

Select Frame Finish: Choose from selected frame finishes

Ego 4 Leg/Sled

RAL metal frame finishes

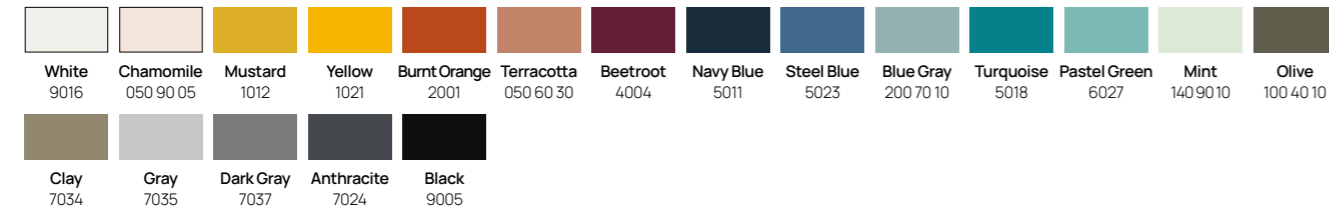

Ego 4 Leg/Sled

Metal frame finishes



1 2 3 4 5

Select Accessories:



Upholstered Seat Pad  
(Available in fabric bands 1-8 - See pages 406-415)





**Ego Chair 4 Leg** (Stacks 8 high)  
width 19.5, depth 20, height 31.5, seat height 18.5"

Color	ORDER CODE	PRICE	
		Chrome Frame	RAL/Raw Frame
White	EGC.4L1/WH	\$315	\$419
Mustard	EGC.4L1/MD	\$315	\$419
Blue	EGC.4L1/BL	\$315	\$419
Steel Blue	EGC.4L1/SB	\$315	\$419
Sage	EGC.4L1/SG	\$315	\$419
Olive	EGC.4L1/OL	\$315	\$419
Gray	EGC.4L1/GY	\$315	\$419
Dark Gray	EGC.4L1/DG	\$315	\$419
Anthracite	EGC.4L1/AN	\$315	\$419
Black	EGC.4L1/BK	\$315	\$419



**Ego Chair Sled** (Stacks 5 high)  
width 21, depth 20, height 31.5, seat height 18.5"

Color	ORDER CODE	PRICE	
		Chrome Frame	RAL/Raw Frame
White	EGC.SL1/WH	\$375	\$446
Mustard	EGC.SL1/MD	\$375	\$446
Blue	EGC.SL1/BL	\$375	\$446
Steel Blue	EGC.SL1/SB	\$375	\$446
Sage	EGC.SL1/SG	\$375	\$446
Olive	EGC.SL1/OL	\$375	\$446
Gray	EGC.SL1/GY	\$375	\$446
Dark Gray	EGC.SL1/DG	\$375	\$446
Anthracite	EGC.SL1/AN	\$375	\$446
Black	EGC.SL1/BK	\$375	\$446



**Ego Stool 4 Leg** (Stacks 4 high)  
width 19.5, depth 21.5, height 44, seat height 31"

Color	ORDER CODE	PRICE	
		Chrome Frame	RAL/Raw Frame
White	EGS.4L1/WH	\$663	\$803
Mustard	EGS.4L1/MD	\$663	\$803
Blue	EGS.4L1/BL	\$663	\$803
Steel Blue	EGS.4L1/SB	\$663	\$803
Sage	EGS.4L1/SG	\$663	\$803
Olive	EGS.4L1/OL	\$663	\$803
Gray	EGS.4L1/GY	\$663	\$803
Dark Gray	EGS.4L1/DG	\$663	\$803
Anthracite	EGS.4L1/AN	\$663	\$803
Black	EGS.4L1/BK	\$663	\$803



**Ego Stool Sled** (Stacks 2 high)  
width 21, depth 21.5, height 44, seat height 31"

Color	ORDER CODE	PRICE	
		Chrome Frame	RAL/Raw Frame
White	EGS.SL1/WH	\$704	\$833
Mustard	EGS.SL1/MD	\$704	\$833
Blue	EGS.SL1/BL	\$704	\$833
Steel Blue	EGS.SL1/SB	\$704	\$833
Sage	EGS.SL1/SG	\$704	\$833
Olive	EGS.SL1/OL	\$704	\$833
Gray	EGS.SL1/GY	\$704	\$833
Dark Gray	EGS.SL1/DG	\$704	\$833
Anthracite	EGS.SL1/AN	\$704	\$833
Black	EGS.SL1/BK	\$704	\$833

**Ego Upholstered Seat Pad**

FABRIC	ORDER CODE	PRICE
1	EGSP.FBB	\$227
2	EGSP.FBC	\$239
3	EGSP.FBD	\$252
4	EGSP.FBE	\$270
5	EGSP.FBF	\$289
6	EGSP.FBG	\$326
7	EGSP.FBH	\$362
8	EGSP.FBI	\$401

# GROW STOOL

Environmentally responsible, the Grow Stool is manufactured from solid cork which is ethically farmed from the bark of cork trees. Robust and tactile - cork adds a natural texture to your interior.



## FEATURES

- 100% solid natural cork
- Sustainable and recyclable design
- Naturally anti-microbial
- Optional seat pad
- Easy movement across all floor surfaces

## STEPS TO SPECIFY

Follow our guide and customize our products to suit your space

1

Select Accessories:

Available in fabric grades 1-8

Fabrics

See pages 406-415

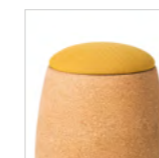

Upholstered Seat Pad



**Grow Stool**  
diameter 17.3, height 16.5"

Color	ORDER CODE	PRICE
Natural Cork	GCS.NSP	\$1,273



**Grow Upholstered Seat Pad**  
diameter 17.3, height 16.5, seat height 18.5"

FABRIC	ORDER CODE	PRICE
1	GCS.WSP.FBB	\$1,498
2	GCS.WSP.FBC	\$1,525
3	GCS.WSP.FBD	\$1,543
4	GCS.WSP.FBE	\$1,582
5	GCS.WSP.FBF	\$1,611
6	GCS.WSP.FBG	\$1,680
7	GCS.WSP.FBH	\$1,742
8	GCS.WSP.FBI	\$1,811

# Booths

HOME	270
HUDDLE CAVE	284
HUDDLE WORK BOOTH	280
JIG CAVE	274
* SAIL BOOTH	256
RETREAT	264

\* New product





# SAIL

\* NEW \*

The Sail booth system addresses privacy for commercial office interiors, by providing a segregated space to collaborate, learn, focus, or relax. It's a refined seating system that allows flexibility and consolidation of workspace in a given area to escape without the need for partitioning or division, promoting collaboration, creativity, and deep concentrative thinking. The ergonomically designed booth has exemplary comfort levels.

## FEATURES

- Suitable for collaborative or independent working
- Elegant organic profile to suit most schemes
- Generous proportions for various number of users
- Laptop holder to make presenting easy
- Soft, sleek, design with curved corners



STEPS TO SPECIFY

Follow our guide and customize our products to suit your space

- ①
- ②
- ③
- ④
- ⑤

Select Size: Two or Four Seater booth, One or Two seater sofa

- ①
- ②
- ③
- ④
- ⑤

Select Power: With or without power options

Sail Booth can be specified with or without power and/ or laptop holder. Please note, North American power will be supplied.

Power includes:  
2x Power Outlet and 1x Twin USB  
(1x Type-A & 1x Type-C)

Laptop Holder:  
Laptop holder for simple presenting with laptop/ tablet



- ①
- ②
- ③
- ④
- ⑤

Select Finish:

Table Top finishes:



**Note:** Sail booths are supplied as standard with tables. Four Seater Booth table: 27.6 x 45.3." Two Seater Booth table: 27.6 x 19.7"

- ①
- ②
- ③
- ④
- ⑤

Select Fabric: Available in fabric bands 1-8

Fabrics  
See pages 406-415

- ①
- ②
- ③
- ④
- ⑤

Select Accessories:



Table top mounted power



Laptop holder

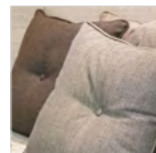

Cushions

For more information on Accessories, see page 366.





Laptop holder & power for instant presenting.



Black fine textured legs

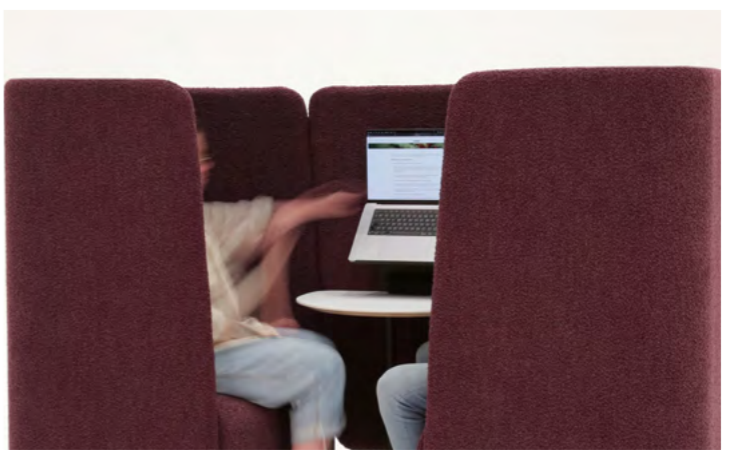

Elegant organic profile

Easy assembly

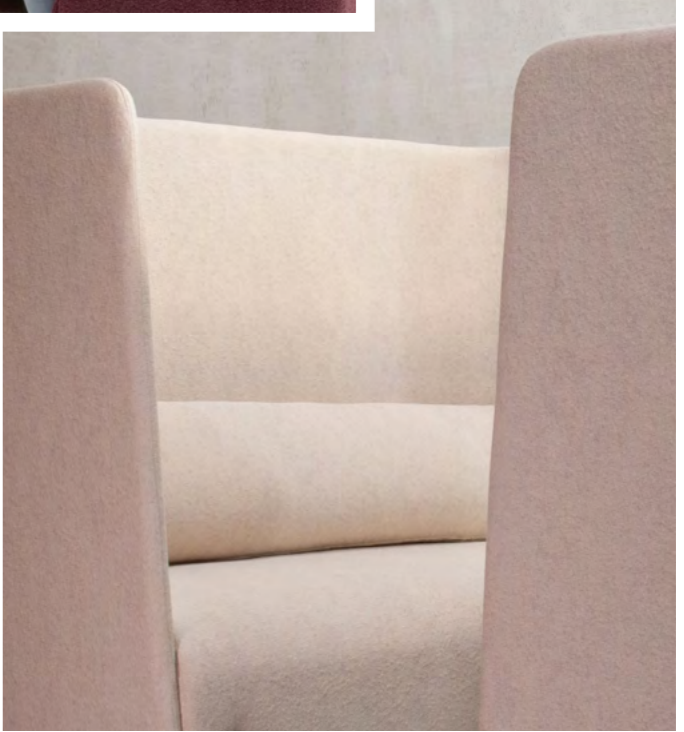



**Sail Booth Two Seater**

width 81.5, depth 38.5, height 54.5, seat height 18"

FABRIC	ORDER CODE	PRICE
1	SIV.2SB.FBB	\$15,439
2	SIV.2SB.FBC	\$16,031
3	SIV.2SB.FBD	\$16,505
4	SIV.2SB.FBE	\$16,980
5	SIV.2SB.FBF	\$17,690
6	SIV.2SB.FBG	\$19,110
7	SIV.2SB.FBH	\$20,532
8	SIV.2SB.FBI	\$21,953
Power		+ \$765
Laptop Holder		+ \$393



**Sail Booth Four Seater**

width 81.5, depth 60, height 54.5, seat height 18"

FABRIC	ORDER CODE	PRICE
1	SIV.4SB.FBB	\$18,236
2	SIV.4SB.FBC	\$19,082
3	SIV.4SB.FBD	\$19,759
4	SIV.4SB.FBE	\$20,434
5	SIV.4SB.FBF	\$21,450
6	SIV.4SB.FBG	\$23,480
7	SIV.4SB.FBH	\$25,512
8	SIV.4SB.FBI	\$27,542
Power		+ \$765
Laptop Holder		+ \$393



**Sail Sofa One Seater**

width 38.5, depth 31, height 54.5, seat height 18"

FABRIC	ORDER CODE	PRICE
1	SIF.1SSF.FBB	\$6,273
2	SIF.1SSF.FBC	\$6,485
3	SIF.1SSF.FBD	\$6,653
4	SIF.1SSF.FBE	\$6,824
5	SIF.1SSF.FBF	\$7,077
6	SIF.1SSF.FBG	\$7,584
7	SIF.1SSF.FBH	\$8,093
8	SIF.1SSF.FBI	\$8,600



**Sail Sofa Two Seater**

width 60, depth 31, height 54.5, seat height 18"

FABRIC	ORDER CODE	PRICE
1	SIF.2SSF.FBB	\$7,578
2	SIF.2SSF.FBC	\$7,881
3	SIF.2SSF.FBD	\$8,124
4	SIF.2SSF.FBE	\$8,366
5	SIF.2SSF.FBF	\$8,729
6	SIF.2SSF.FBG	\$9,457
7	SIF.2SSF.FBH	\$10,184
8	SIF.2SSF.FBI	\$10,912



# RETREAT

Retreat has been designed to embrace the new way of working and office design. It is a modular piece of 'micro architecture' which sits as a hybrid between the traditional glass box meeting pods and an upholstered booth sofa, with a focus and consideration towards human interaction.



## FEATURES

- Use of sustainable materials such as Bamboo and PET Felt
- Developed for informal team meetings and spontaneous catch ups and the new way of digitally communicating
- Quick assembly
- Integrated power for charging
- Cable management for lighting with switch
- Mobility kit included
- Adjustable feet
- Acoustic enhancement



### STEPS TO SPECIFY

Follow our guide and customize our products to suit your space

- 1
- 2
- 3
- 4
- 5

Select Configuration: Piece together different modules and add accessories  
Example configurations shown below

Outer panel finish    Metal pergola finish



Bamboo



Black  
9005

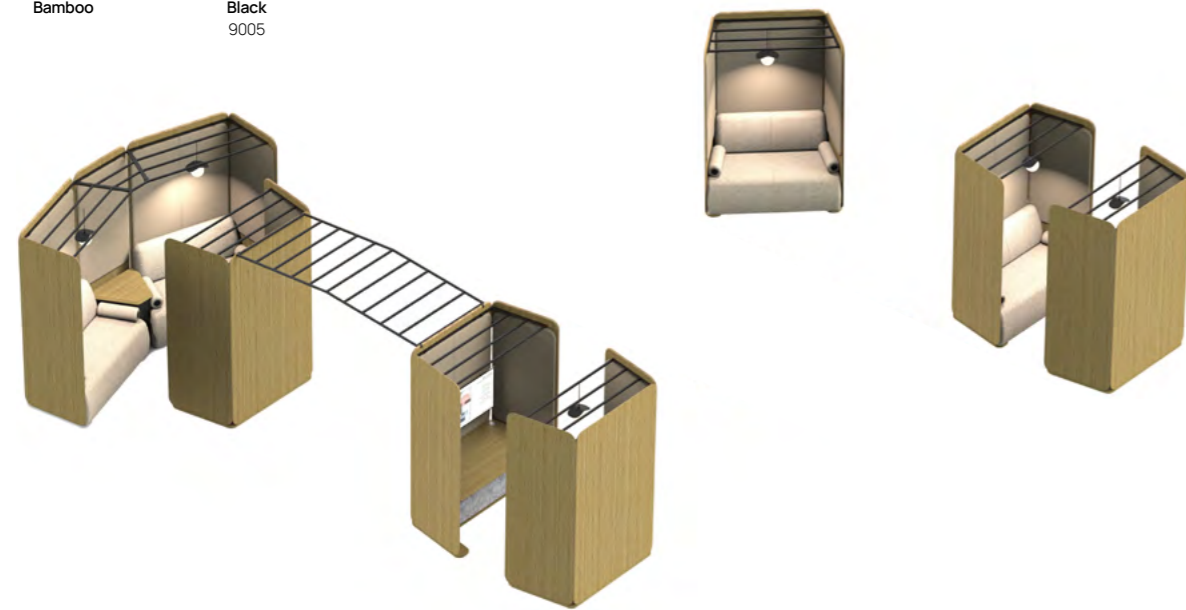

Supplied as standard per Retreat module, including integrated power:



Power Cushion  
Modules available  
in Black. Fabric will  
match the sofa.

Retreat - Two Seater includes:

- 1x Pair of Power Cushions that include 1x Twin USB Charge (1x Type-C & 1x Type-A).

Retreat Cove - Four Seater includes:

- 2x Pair of Power Cushions that include 1x Twin USB Charge (1x Type-C & 1x Type-A).

Retreat - Media Center includes:

- 1x Power Unit
- 1x Monitor Mount
- 1x Camera Mount

Note: Lighting is unavailable in North America. All power will be supplied with North American variant. Monitor, webcam and computer are not supplied by Frövi. Recommended screen size is 42 inches.

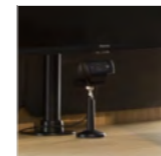

Monitor and  
Camera Mount  
Available in Black  
Media Center only



Power Unit  
1x Power Outlet  
Available in Black  
Media Center only

- 1
- 2
- 3
- 4
- 5

Select Inner Panel Finish: Svensson Macro 6841 or 3560

Fabric panel finishes



Macro  
6841



Macro  
3560

- 1
- 2
- 3
- 4
- 5

Select Sofa Fabric: (sofa modules only) Available in fabric grades 1-8

Fabrics

See pages 406-415

- 1
- 2
- 3
- 4
- 5

Select Felt Finish: (media centers only) Camel Fleck or Dark Gray

Felt Finishes



Camel Fleck



Dark Gray

- 1
- 2
- 3
- 4
- 5

Select Accessories:



Moss Panel  
(Plants sold  
separately)



Mesh Panel  
(Plants sold  
separately)



Lighting NOT available in North America. Metal pergola is supplied as standard for you to specify your own lighting solution.



**Retreat Two Seater**  
width 58, depth 30, height 83"

FABRIC BAND	ORDER CODE	PRICE
1	RTS.FBB	\$20,741
2	RTS.FBC	\$20,976
3	RTS.FBD	\$21,165
4	RTS.FBE	\$21,353
5	RTS.FBF	\$21,636
6	RTS.FBG	\$22,202
7	RTS.FBH	\$22,768
8	RTS.FBI	\$23,334



**Retreat Cove - Four Seater**  
width 121, depth 44.5, height 83"

FABRIC BAND	ORDER CODE	PRICE
1	RTCO.FBB	\$39,169
2	RTCO.FBC	\$39,629
3	RTCO.FBD	\$39,997
4	RTCO.FBE	\$40,365
5	RTCO.FBF	\$40,919
6	RTCO.FBG	\$42,023
7	RTCO.FBH	\$43,130
8	RTCO.FBI	\$44,234



**Retreat Media Center**  
width 58, depth 30, height 83"

DESCRIPTION	ORDER CODE	PRICE
Media Center	RCMC	\$18,274

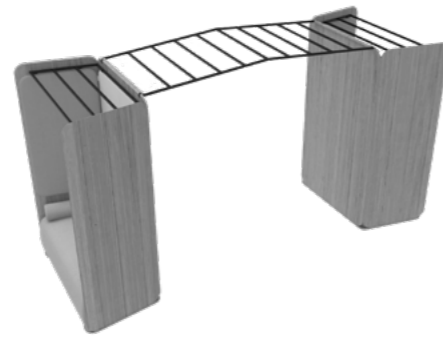

**Retreat Pergola Bridge** *Sofa modules sold separately*  
width 39.5, depth 96, height 4.5"

DESCRIPTION	ORDER CODE	PRICE
Pergola Bridge	RTPB	\$1,976



**Retreat Moss Panel** *Plants and sofa modules sold separately*  
width 19.5, depth 2, height 77"

DESCRIPTION	ORDER CODE	PRICE
Moss Panel	RTMP	\$764



**Retreat Mesh Panel** *Plants and sofa modules sold separately*  
width 20.5, depth 1.5, height 77"

DESCRIPTION	ORDER CODE	PRICE
Mesh Panel	RTMSP	\$764



# HOME BOOTH

---

More than a traditional booth, Home offers mobility and flexibility. Each piece can stand alone and be used in its own right, allowing users to organise their space into task related areas. Adding castors to Home allows users to manoeuvre them when and where required, still encouraging collaboration and teamwork whilst maintaining social distancing.



## FEATURES

---

- Available with castor option for mobility
- Side cushions removable for additional seat width
- Mobile Media Wall with concealed cable management
- Mobile Media Wall offer acoustic properties
- Extensive range of accessories including integrated table and media package
- Webbed seat for maximum comfort
- Black frame finish



For the full Home collection, see page 172..



STEPS TO SPECIFY

Follow our guide and customize our products to suit your space

1 2 3

Select Configuration: Piece together the Home High Sofa and add the Mobile Media Wall to create a Booth setup. Example configuration shown below



1 2 3

Choose Fabric: Available in fabric grades 1-8

Fabrics  
See pages 406-415

1 2 3

Select Accessories:

ACCESSORIES



MOBILE MEDIA WALL ACCESSORIES



Each Power Shelf includes:  
2x Power Outlet, 1x Twin USB (1x Type-A & 1x Type-C) & 1x HDMI as standard with additional Power Outlet socket for monitor.  
Monitors are not supplied by Frövi and a 28 inch screen size is recommended. Integrated cable management.



**Home High Sofa Two Seater**  
width 71.5, depth 32.5, height 56, seat height 17.5"

FABRIC	ORDER CODE	PRICE
1	HOF.2SH.BK.NCA.FBB	\$10,839
2	HOF.2SH.BK.NCA.FBC	\$11,503
3	HOF.2SH.BK.NCA.FBD	\$12,165
4	HOF.2SH.BK.NCA.FBE	\$13,157
5	HOF.2SH.BK.NCA.FBF	\$14,153
6	HOF.2SH.BK.NCA.FBG	\$16,142
7	HOF.2SH.BK.NCA.FBH	\$18,133
8	HOF.2SH.BK.NCA.FBI	\$20,125

One Coat Hook supplied per High Sofa



**Home Mobile Media Wall**  
width 60, depth 18.5, height 56.5, panel depth 2"

FABRIC	ORDER CODE		PRICE
	Standard Height	Bar Height	
1	HOMW.SHT.BK.FBB	HOMW.PHT.BK.FBB	\$3,044
2	HOMW.SHT.BK.FBC	HOMW.PHT.BK.FBC	\$3,214
3	HOMW.SHT.BK.FBD	HOMW.PHT.BK.FBD	\$3,384
4	HOMW.SHT.BK.FBE	HOMW.PHT.BK.FBE	\$3,642
5	HOMW.SHT.BK.FBF	HOMW.PHT.BK.FBF	\$3,898
6	HOMW.SHT.BK.FBG	HOMW.PHT.BK.FBG	\$4,409
7	HOMW.SHT.BK.FBH	HOMW.PHT.BK.FBH	\$4,917
8	HOMW.SHT.BK.FBI	HOMW.PHT.BK.FBI	\$5,431

Home Accessories

DESCRIPTION	ORDER CODE	PRICE
Accessories		
Laptop Table	HOLT.BK	\$1,254
Castors	WCA	\$571
Coat Hook	HOHK	\$66

One Coat Hook supplied per High Sofa FOC

DESCRIPTION	ORDER CODE	PRICE		
		Standard	Rustic	Fenix
Mobile Media Wall Accessories				
Table	HOTT.BK	\$1,126	\$1,928	\$2,727
Power Shelf	HOPS.HO/2UK/TU/H/BK	\$606		
White board	HOWB	\$542		
Monitor Mount	HOMM	\$182		



# JIG CAVE

---

Designed for reducing noise within busy areas, Jig Cave has deep buttoned sides that both absorb sound and add a distinctive style. Jig Cave has optional media, ideal for collaborative tasks and online meetings.



## FEATURES

---

- Solid oak frame and laminate table top for heavy traffic areas
- Highly effective acoustic properties for noise cancellation
- Extensive range of fabrics available
- Optional contrasting buttons
- Optional power and media pack



## STEPS TO SPECIFY

Follow our guide and customize our products to suit your space

1 2 3 4 5

Select Size: Two, Four or Six Seater

1 2 3 4 5

Select Media: Media or Power only.

Jig Cave Four and Six Seaters can be specified with or without integrated media.  
Monitors are not supplied by Frövi. 28 inch screen size is recommended.

Power includes:  
2x Power Outlet (in central panel) and 1x Twin USB  
(1x Type-A & 1x Type-C)

Media includes:  
1x Power Outlet, 1x Twin USB (1x Type-A & 1x Type-C),  
1x HDMI and 1x Power Outlet for monitor behind mount.



1 2 3 4 5

Select Frame Finish:

Wood frame finishes



Natural Oak    Black Oak    Stained Walnut

**Note:** Jig Caves are supplied as standard with table tops to match the frame finish; white table tops are also available. Four Seater - 39.3 x 23.6.  
Six Seater - 59 x 23.6\*. Jig Cave Two Seater is supplied with a shelf that matches the frame - 23.6 x 9.8\*.

1 2 3 4 5

Select Fabric: Available in fabric grades 1-8

Fabrics  
See pages 406-415

1 2 3 4 5

Select Accessories:

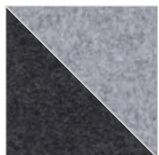

Two-tone fabric choice  
(Price at next fabric band)

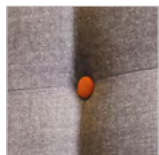

Contrasting buttons



Duet Power  
(Please specify if you would like sofa or table mounted power)

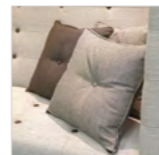

Cushions

All buttons will be matching fabric unless specifically requested. No up-charge for contrasting buttons from the same fabric range.  
For more information on Accessories, see page 366.

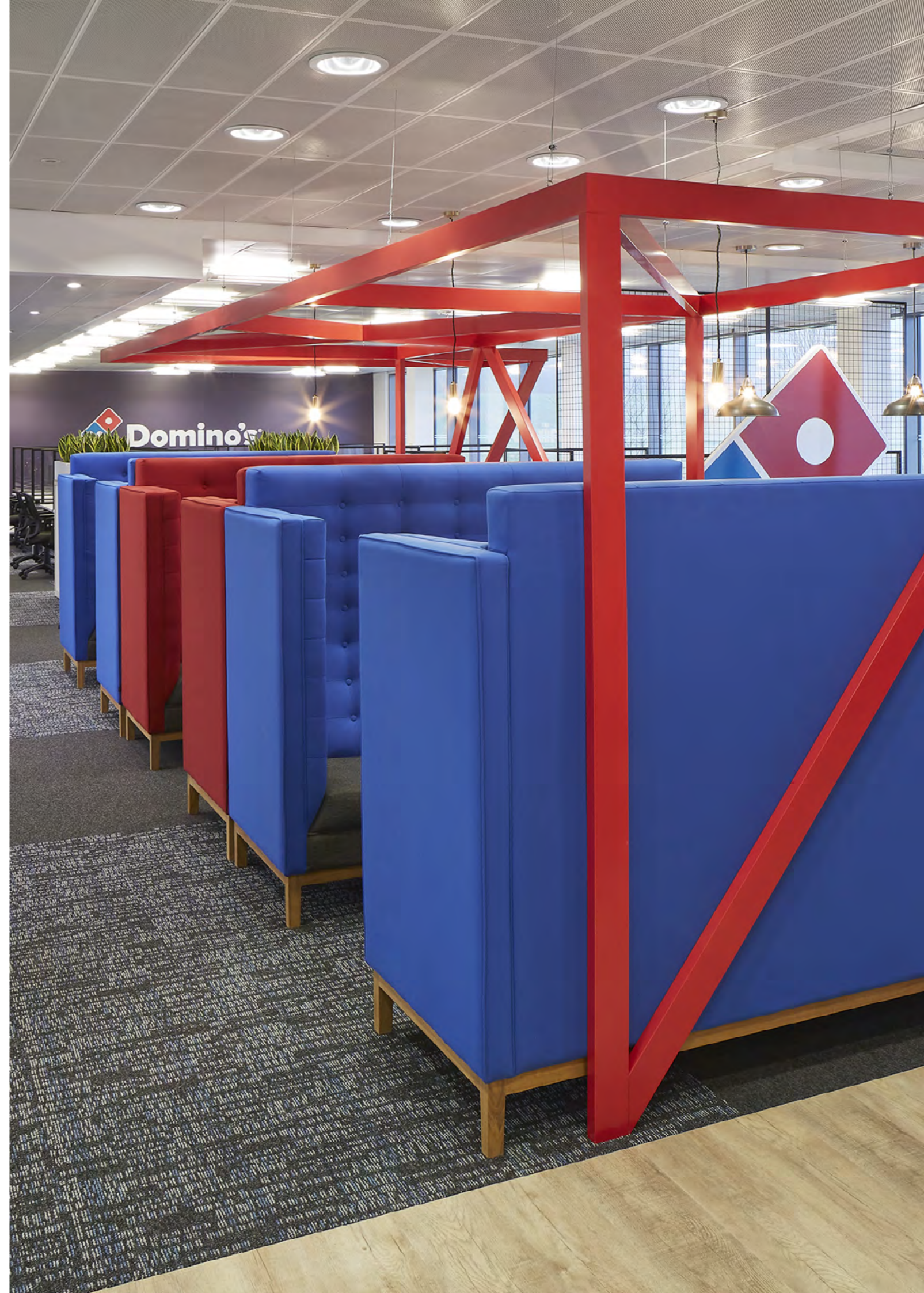



**Jig Cave Four Seater**  
width 91.5, depth 59, height 58, seat height 17"

FABRIC	ORDER CODE	PRICE
1	JIV.4SB.FBB	\$20,561
2	JIV.4SB.FBC	\$21,689
3	JIV.4SB.FBD	\$22,819
4	JIV.4SB.FBE	\$24,508
5	JIV.4SB.FBF	\$26,205
6	JIV.4SB.FBG	\$29,587
7	JIV.4SB.FBH	\$32,977
8	JIV.4SB.FBI	\$36,357



**Jig Cave Four Seater (Power)**  
width 91.5, depth 60, height 58, seat height 17"

FABRIC	ORDER CODE	PRICE
1	JIV.4SB.PWR.FBB	\$22,322
2	JIV.4SB.PWR.FBC	\$23,427
3	JIV.4SB.PWR.FBD	\$24,533
4	JIV.4SB.PWR.FBE	\$26,197
5	JIV.4SB.PWR.FBF	\$27,863
6	JIV.4SB.PWR.FBG	\$31,188
7	JIV.4SB.PWR.FBH	\$34,510
8	JIV.4SB.PWR.FBI	\$37,835



**Jig Cave Four Seater (Media)**  
width 91.5, depth 59, height 58, seat height 17"

FABRIC	ORDER CODE	PRICE
1	JIV.4SB.MED.FBB	\$22,676
2	JIV.4SB.MED.FBC	\$23,804
3	JIV.4SB.MED.FBD	\$24,932
4	JIV.4SB.MED.FBE	\$26,623
5	JIV.4SB.MED.FBF	\$28,316
6	JIV.4SB.MED.FBG	\$31,700
7	JIV.4SB.MED.FBH	\$35,088
8	JIV.4SB.MED.FBI	\$38,472



**Jig Cave Six Seater**  
width 91.5, depth 78.5, height 58, seat height 17"

FABRIC	ORDER CODE	PRICE
1	JIV.6SB.FBB	\$23,081
2	JIV.6SB.FBC	\$24,297
3	JIV.6SB.FBD	\$25,505
4	JIV.6SB.FBE	\$27,321
5	JIV.6SB.FBF	\$29,139
6	JIV.6SB.FBG	\$32,779
7	JIV.6SB.FBH	\$36,414
8	JIV.6SB.FBI	\$40,046



**Jig Cave Six Seater (Power)**  
width 91.5, depth 78.5, height 58, seat height 17"

FABRIC	ORDER CODE	PRICE
1	JIV.6SB.PWR.FBB	\$24,848
2	JIV.6SB.PWR.FBC	\$26,035
3	JIV.6SB.PWR.FBD	\$27,225
4	JIV.6SB.PWR.FBE	\$29,010
5	JIV.6SB.PWR.FBF	\$30,793
6	JIV.6SB.PWR.FBG	\$34,367
7	JIV.6SB.PWR.FBH	\$37,943
8	JIV.6SB.PWR.FBI	\$41,512



**Jig Cave Six Seater (Media)**  
width 91.5, depth 78.5, height 58, seat height 17"

FABRIC	ORDER CODE	PRICE
1	JIV.6SB.MED.FBB	\$25,192
2	JIV.6SB.MED.FBC	\$26,406
3	JIV.6SB.MED.FBD	\$27,620
4	JIV.6SB.MED.FBE	\$29,438
5	JIV.6SB.MED.FBF	\$31,255
6	JIV.6SB.MED.FBG	\$34,889
7	JIV.6SB.MED.FBH	\$38,525
8	JIV.6SB.MED.FBI	\$42,160



**Jig Cave Two Seater**  
width 91.5, depth 41, height 58, seat height 17"

FABRIC	ORDER CODE	PRICE
1	JIV.2SB.FBB	\$16,731
2	JIV.2SB.FBC	\$17,730
3	JIV.2SB.FBD	\$18,733
4	JIV.2SB.FBE	\$20,238
5	JIV.2SB.FBF	\$21,742
6	JIV.2SB.FBG	\$24,748
7	JIV.2SB.FBH	\$27,759
8	JIV.2SB.FBI	\$30,768

**Jig Cave Power includes:**

- 
- Upholstered screen with table
  - Integrated power including:
    - 2x Power Sockets
    - 1x Twin USB (1x Type-A & 1x Type-C)

**Jig Cave Media includes:**

- 
- Upholstered screen with table
  - Monitor mount
  - Integrated power including:
    - 2x Power Sockets (1 behind the screen)
    - 1x Twin USB (1x Type-A & 1x Type-C)
    - 1x HDMI
- Note: Monitors are not supplied by Frövi.  
Recommended screen size is 28 inches.

# HUDDLE WORK BOOTH

---

This striking addition to the Huddle range is compact and features soft cushion upholstery, generating excellent comfort. Huddle Work Booth creates a contemporary seating arrangement ideal for solo working - a perfect mobile hideaway for focused concentration.



## FEATURES

---

- Compact work booth with a number of accessories to aid solo working
- Optional power module
- Optional castors
- Deep foam seat and back rests for extra comfort
- Effective acoustic design for noise reduction
- Extensive range of fabrics with two-tone fabric option
- Fixed work surface, ergonomically designed
- Coat hook available as standard



STEPS TO SPECIFY

Follow our guide and customize our products to suit your space

- 1
- 2
- 3

Select Fabric: Available in fabric grades 1-8

Fabrics  
See pages 406-415

- 1
- 2
- 3

Select Feet: Choose from fixed foot or rear locking castors



Chrome Feet



Black Feet



Black Castors

Huddle Work Booth is supplied as standard with a White MFC 24.6 x 19.4" Table

- 1
- 2
- 3

Choose Additional Accessories:



Two-tone fabric choice  
(Price at next fabric band)



Solo Power Unit  
1x Power Outlet & 1x Twin USB Charge.  
(1x Type-C & 1x Type-A)  
Available in Black.



**Huddle Work Booth Left-hand Single Seater**  
width 37, depth 49.5, height 58.5, seat height 17.5"

FABRIC	ORDER CODE		PRICE
	Chrome Feet	Black Feet	
1	HUBH.FNP.CH.FBB	HUBH.FNP.BK.FBB	\$7,731
2	HUBH.FNP.CH.FBC	HUBH.FNP.BK.FBC	\$8,261
3	HUBH.FNP.CH.FBD	HUBH.FNP.BK.FBD	\$8,790
4	HUBH.FNP.CH.FBE	HUBH.FNP.BK.FBE	\$9,586
5	HUBH.FNP.CH.FBF	HUBH.FNP.BK.FBF	\$10,381
6	HUBH.FNP.CH.FBG	HUBH.FNP.BK.FBG	\$11,972
7	HUBH.FNP.CH.FBH	HUBH.FNP.BK.FBH	\$13,562

One Coat Hook supplied per Work Booth



**Huddle Work Booth Left-hand Single Seater with Solo Power**  
width 37, depth 49.5, height 58.5, seat height 17.5"

FABRIC	ORDER CODE		PRICE
	Chrome Feet	Black Feet	
1	HUBH.FWP.CH.SP1.FBB	HUBH.FWP.BK.SP1.FBB	\$8,773
2	HUBH.FWP.CH.SP1.FBC	HUBH.FWP.BK.SP1.FBC	\$9,302
3	HUBH.FWP.CH.SP1.FBD	HUBH.FWP.BK.SP1.FBD	\$9,835
4	HUBH.FWP.CH.SP1.FBE	HUBH.FWP.BK.SP1.FBE	\$10,630
5	HUBH.FWP.CH.SP1.FBF	HUBH.FWP.BK.SP1.FBF	\$11,423
6	HUBH.FWP.CH.SP1.FBG	HUBH.FWP.BK.SP1.FBG	\$13,016
7	HUBH.FWP.CH.SP1.FBH	HUBH.FWP.BK.SP1.FBI	\$14,607

One Coat Hook supplied per Work Booth



**Huddle Work Booth Left-hand Single Seater on Castors**  
width 37, depth 49.5, height 58.5, seat height 17.5"

FABRIC	ORDER CODE	PRICE
	Black Castors	
1	HUBH.CNP.FBB	\$8,329
2	HUBH.CNP.FBC	\$8,860
3	HUBH.CNP.FBD	\$9,391
4	HUBH.CNP.FBE	\$10,186
5	HUBH.CNP.FBF	\$10,982
6	HUBH.CNP.FBG	\$12,572
7	HUBH.CNP.FBH	\$14,161

One Coat Hook supplied per Work Booth



**Huddle Work Booth Left-hand Single Seater on Castors with Solo**  
width 37, depth 49.5, height 58.5, seat height 17.5"

FABRIC	ORDER CODE	PRICE
	Black Castors	
1	HUBH.CWP.CA/BK.FBB	\$9,291
2	HUBH.CWP.CA/BK.FBC	\$9,817
3	HUBH.CWP.CA/BK.FBD	\$10,344
4	HUBH.CWP.CA/BK.FBE	\$11,130
5	HUBH.CWP.CA/BK.FBF	\$11,915
6	HUBH.CWP.CA/BK.FBG	\$13,490
7	HUBH.CWP.CA/BK.FBH	\$15,066

One Coat Hook supplied per Work Booth



# HUDDLE CAVE

---

With clean lines and an uncomplicated design, Huddle Cave offers a sanctuary for a wide range of working activities. It has optional media, ideal for collaborative tasks and online meetings.



## FEATURES

---

- Deep seat and back rests for lumbar support
- Effective acoustic design for noise reduction
- Integrated laminate top table
- Extensive range of fabrics available
- Optional power and media pack



## STEPS TO SPECIFY

Follow our guide and customize our products to suit your space

1 2 3 4 5

Select Size: Two, Four or Six Seater

1 2 3 4 5

Select Media: Media or Power only.

The Huddle Cave can be specified with or without integrated media.

Monitors are not supplied by Frövi. 28 inch screen size is recommended.

Power includes:

2x Power Outlet (in central panel) and 1x Twin USB (1x Type-A & 1x Type-C)

Media includes:

1x Power Outlet, 1x Twin USB (1x Type-A & 1x Type-C), 1x HDMI and 1x Power Outlet for monitor behind mount.



1 2 3 4 5

Select Feet Finish:



Chrome Feet



Black Feet

**Note:** Huddle Cave Four and Six Seaters are supplied with a joining screen and a White cutline edge laminate table with a matching finish support leg. Four Seater - 31.5 x 23.5". Six Seater - 55 x 23.5". Huddle Cave Two Seater is supplied with a White cutline edge 23.5 x 10" shelf.

1 2 3 4 5

Select Fabric: Available in fabric grades 1-8

Fabrics

See pages 406-415

1 2 3 4 5

Select Accessories:



Two-tone fabric choice (Price at next fabric band)



Duet Power (Please specify if you would like sofa or table mounted power)

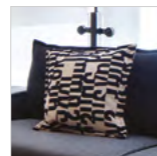

Cushions

For more information on Accessories, see page 366.







**Huddle Cave Four Seater**

width 89.5, depth 53.5, height 58.5, seat height 17.5"

FABRIC	ORDER CODE		PRICE
	Chrome Feet	Black Feet	
1	HUV.4SB.CH.FBB	HUV.4SB.BK.FBB	\$17,179
2	HUV.4SB.CH.FBC	HUV.4SB.BK.FBC	\$18,415
3	HUV.4SB.CH.FBD	HUV.4SB.BK.FBD	\$19,644
4	HUV.4SB.CH.FBE	HUV.4SB.BK.FBE	\$21,501
5	HUV.4SB.CH.FBF	HUV.4SB.BK.FBF	\$23,354
6	HUV.4SB.CH.FBG	HUV.4SB.BK.FBG	\$27,053
7	HUV.4SB.CH.FBH	HUV.4SB.BK.FBH	\$30,760
8	HUV.4SB.CH.FBI	HUV.4SB.BK.FBI	\$34,463



**Huddle Cave Four Seater (Power)**

width 89.5, depth 53.5, height 58.5, seat height 17.5"

FABRIC	ORDER CODE		PRICE
	Chrome Feet	Black Feet	
1	HUV.4SB.CH.PWR.FBB	HUV.4SB.BK.PWR.FBB	\$19,456
2	HUV.4SB.CH.PWR.FBC	HUV.4SB.BK.PWR.FBC	\$20,642
3	HUV.4SB.CH.PWR.FBD	HUV.4SB.BK.PWR.FBD	\$21,826
4	HUV.4SB.CH.PWR.FBE	HUV.4SB.BK.PWR.FBE	\$23,604
5	HUV.4SB.CH.PWR.FBF	HUV.4SB.BK.PWR.FBF	\$25,380
6	HUV.4SB.CH.PWR.FBG	HUV.4SB.BK.PWR.FBG	\$28,937
7	HUV.4SB.CH.PWR.FBH	HUV.4SB.BK.PWR.FBH	\$32,491
8	HUV.4SB.CH.PWR.FBI	HUV.4SB.BK.PWR.FBI	\$36,039



**Huddle Cave Four Seater (Media)**

width 89.5, depth 53.5, height 58.5, seat height 17.5"

FABRIC	ORDER CODE		PRICE
	Chrome Feet	Black Feet	
1	HUV.4SB.CH.MED.FBB	HUV.4SB.BK.MED.FBB	\$19,493
2	HUV.4SB.CH.MED.FBC	HUV.4SB.BK.MED.FBC	\$20,727
3	HUV.4SB.CH.MED.FBD	HUV.4SB.BK.MED.FBD	\$21,961
4	HUV.4SB.CH.MED.FBE	HUV.4SB.BK.MED.FBE	\$23,815
5	HUV.4SB.CH.MED.FBF	HUV.4SB.BK.MED.FBF	\$25,664
6	HUV.4SB.CH.MED.FBG	HUV.4SB.BK.MED.FBG	\$29,371
7	HUV.4SB.CH.MED.FBH	HUV.4SB.BK.MED.FBH	\$33,079
8	HUV.4SB.CH.MED.FBI	HUV.4SB.BK.MED.FBI	\$36,784



**Huddle Cave Six Seater**

width 89.5, depth 77, height 58.5, seat height 17.5"

FABRIC	ORDER CODE		PRICE
	Chrome Feet	Black Feet	
1	HUV.6SB.CH.FBB	HUV.6SB.BK.FBB	\$22,488
2	HUV.6SB.CH.FBC	HUV.6SB.BK.FBC	\$24,084
3	HUV.6SB.CH.FBD	HUV.6SB.BK.FBD	\$25,687
4	HUV.6SB.CH.FBE	HUV.6SB.BK.FBE	\$28,086
5	HUV.6SB.CH.FBF	HUV.6SB.BK.FBF	\$30,493
6	HUV.6SB.CH.FBG	HUV.6SB.BK.FBG	\$35,294
7	HUV.6SB.CH.FBH	HUV.6SB.BK.FBH	\$40,094
8	HUV.6SB.CH.FBI	HUV.6SB.BK.FBI	\$44,898



**Huddle Cave Six Seater (Power)**

width 89.5, depth 77, height 58.5, seat height 17.5"

FABRIC	ORDER CODE		PRICE
	Chrome Feet	Black Feet	
1	HUV.6SB.CH.PWR.FBB	HUV.6SB.BK.PWR.FBB	\$24,654
2	HUV.6SB.CH.PWR.FBC	HUV.6SB.BK.PWR.FBC	\$26,202
3	HUV.6SB.CH.PWR.FBD	HUV.6SB.BK.PWR.FBD	\$27,752
4	HUV.6SB.CH.PWR.FBE	HUV.6SB.BK.PWR.FBE	\$30,075
5	HUV.6SB.CH.PWR.FBF	HUV.6SB.BK.PWR.FBF	\$32,402
6	HUV.6SB.CH.PWR.FBG	HUV.6SB.BK.PWR.FBG	\$37,053
7	HUV.6SB.CH.PWR.FBH	HUV.6SB.BK.PWR.FBH	\$41,704
8	HUV.6SB.CH.PWR.FBI	HUV.6SB.BK.PWR.FBI	\$46,356



**Huddle Cave Six Seater (Media)**

width 89.5, depth 77, height 58.5, seat height 17.5"

FABRIC	ORDER CODE		PRICE
	Chrome Feet	Black Feet	
1	HUV.6SB.CH.MED.FBB	HUV.6SB.BK.MED.FBB	\$24,834
2	HUV.6SB.CH.MED.FBC	HUV.6SB.BK.MED.FBC	\$26,438
3	HUV.6SB.CH.MED.FBD	HUV.6SB.BK.MED.FBD	\$28,038
4	HUV.6SB.CH.MED.FBE	HUV.6SB.BK.MED.FBE	\$30,441
5	HUV.6SB.CH.MED.FBF	HUV.6SB.BK.MED.FBF	\$32,838
6	HUV.6SB.CH.MED.FBG	HUV.6SB.BK.MED.FBG	\$37,645
7	HUV.6SB.CH.MED.FBH	HUV.6SB.BK.MED.FBH	\$42,443
8	HUV.6SB.CH.MED.FBI	HUV.6SB.BK.MED.FBI	\$47,244



**Huddle Cave Two Seater**

width 89.5, depth 30, height 58.5, seat height 17.5"

FABRIC	ORDER CODE		PRICE
	Chrome Feet	Black Feet	
1	HUV.2SB.CH.FBB	HUV.2SB.BK.FBB	\$12,627
2	HUV.2SB.CH.FBC	HUV.2SB.BK.FBC	\$13,496
3	HUV.2SB.CH.FBD	HUV.2SB.BK.FBD	\$14,366
4	HUV.2SB.CH.FBE	HUV.2SB.BK.FBE	\$15,672
5	HUV.2SB.CH.FBF	HUV.2SB.BK.FBF	\$16,976
6	HUV.2SB.CH.FBG	HUV.2SB.BK.FBG	\$19,582
7	HUV.2SB.CH.FBH	HUV.2SB.BK.FBH	\$22,190
8	HUV.2SB.CH.FBI	HUV.2SB.BK.FBI	\$24,792

**Huddle Cave Media includes:**

- Upholstered screen with table
- Monitor mount
- Integrated power including:
  - 2x Power Sockets (1 behind the screen)
  - 1x Twin USB (1x Type-A & 1x Type-C)
  - 1x HDMI

Note: Monitors are not supplied by Frövi. Recommended screen size is 28 inches.

**Huddle Cave Power includes:**

- Upholstered screen with table
- Integrated power including:
  - 2x Power Sockets
  - 1x Twin USB (1x Type-A & 1x Type-C)

# Tables

FLORD TABLE	320
FONT TABLE	292
FOUNDRY GIANT	328
LAPTOP TABLE	350
MARGIN TABLE	332
MONO GIANT TABLE	340
MONO TABLE	336
ORBIT TABLE	304
OSTI	316
OSTI CLOUD	312
* PEGGY	296
PEEL TABLE	300
SLENDRA TABLE	322
WIRE COFFEE TABLE	346
WRAPT COFFEE TABLE	308
YAK COFFEE TABLE	342

\* New product



# FONT TABLE

---

Simplicity and functionality unite to create the versatile and practical Font Table. The classic style of the Font Table makes it the ideal canteen, breakout, or work table for any environment. Customise your Font Table with either round or soft square MFC table tops for a hard wearing, timeless look. With a classic black tubular steel frame the Font Table is the perfectly stylish and functional accompaniment to any workspace.



## FEATURES

---

- Strong tubular steel construction
- Four top finishes and two formats available
- Frame available in black
- Suitable pairing with many chairs
- Height adjustable levelling feet
- Delivered flat-pack for easy install



## STEPS TO SPECIFY

Follow our guide and customize our products to suit your space

1 2 3

Select Table Top Format: Round or Soft Square

1 2 3

Select Frame Finish: Black frame finish only

RAL metal frame finish



Black

1 2 3

Select Table Top Finish: Choose from selected finishes



MFC  
top thickness 1"

Standard



White



Anthracite

Rustic



Rustic Oak



Rustic  
Black Oak



### Font Table

width 35.5, depth 35.5, height 29"

SIZE (Inch)	ORDER CODE	PRICE	
		Standard	Rustic
35.5 dia	FNT.90D.BK	\$1,507	\$1,750
35.5 x 35.5	FNT.90SR.BK	\$1,507	\$1,750



# PEGGY TABLE

\* NEW \*

The perfect addition to your flexible and agile working space, Peggy is a refined and functional laptop table made from solid ash. Designed to complement any soft seating range, its sleek and minimalist design allows for easy integration into any environment, while its sturdy construction ensures durability and reliability. Whether you're working from home or in a shared workspace, the ergonomic tabletop allows for comfort whilst working on your laptop.



## FEATURES

- The slightly exaggerated stem angle gives more reach to the user and provides stability
- The under table cross piece feature is celebrated rather than trying to give an anti-gravity look
- The unique tabletop shape allows user to use the table front on or side on comfortably
- Small Shadow gap underneath the legs



## STEPS TO SPECIFY

Follow our guide and customize our products to suit your space

1

Select table finish: Choose from selected finishes.

Wood frame finishes



Natural Ash    Black (Stained Ash)    Oak (Stained Ash)



### Peggy Table

width 26, depth 19.5, height 21.5"

DESCRIPTION	ORDER CODE			PRICE
Laptop Table	Natural Ash	Black (Stained Ash)	Oak (Stained Ash)	\$1,021



# PEEL TABLE

---

Drawing upon the contemporary features of simplicity, subtle sophistication and clean lines, the Peel Table has been created to add an eye-catching modern twist to a beautiful timeless design. With a contemporary sleek silhouette combined with a unique and elegant 'peeled back' handle, the functionality and subtle allure of this table is unquestionable. The Peel Table is an ideal fit for work environments with its tough commercial durability.



## FEATURES

---

Contemporary Coffee & Side Table

Residential aesthetic with commercial durability

Tripod frame for mid-century style

Available in a range of frame finishes



STEPS TO SPECIFY

Follow our guide and customize our products to suit your space

1 2

Select Product: Side or Coffee Table

1 2

Select Frame Finish: Colored or Raw Steel

RAL metal frame finishes

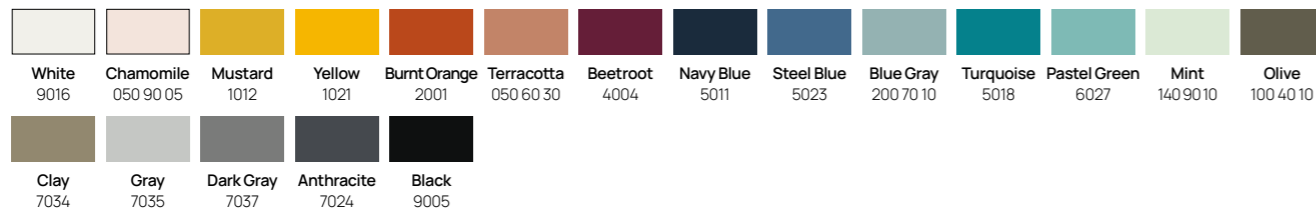

Metal frame finishes



**Peel Side Table**  
width 20.5, depth 20.5, table height 20"

DESCRIPTION	ORDER CODE	PRICE
Side Table	PLL.SHT	\$1,279



**Peel Coffee Table**  
width 31.5, depth 31.5, table height 15"

DESCRIPTION	ORDER CODE	PRICE
Coffee Table	PLL.LHT	\$1,734

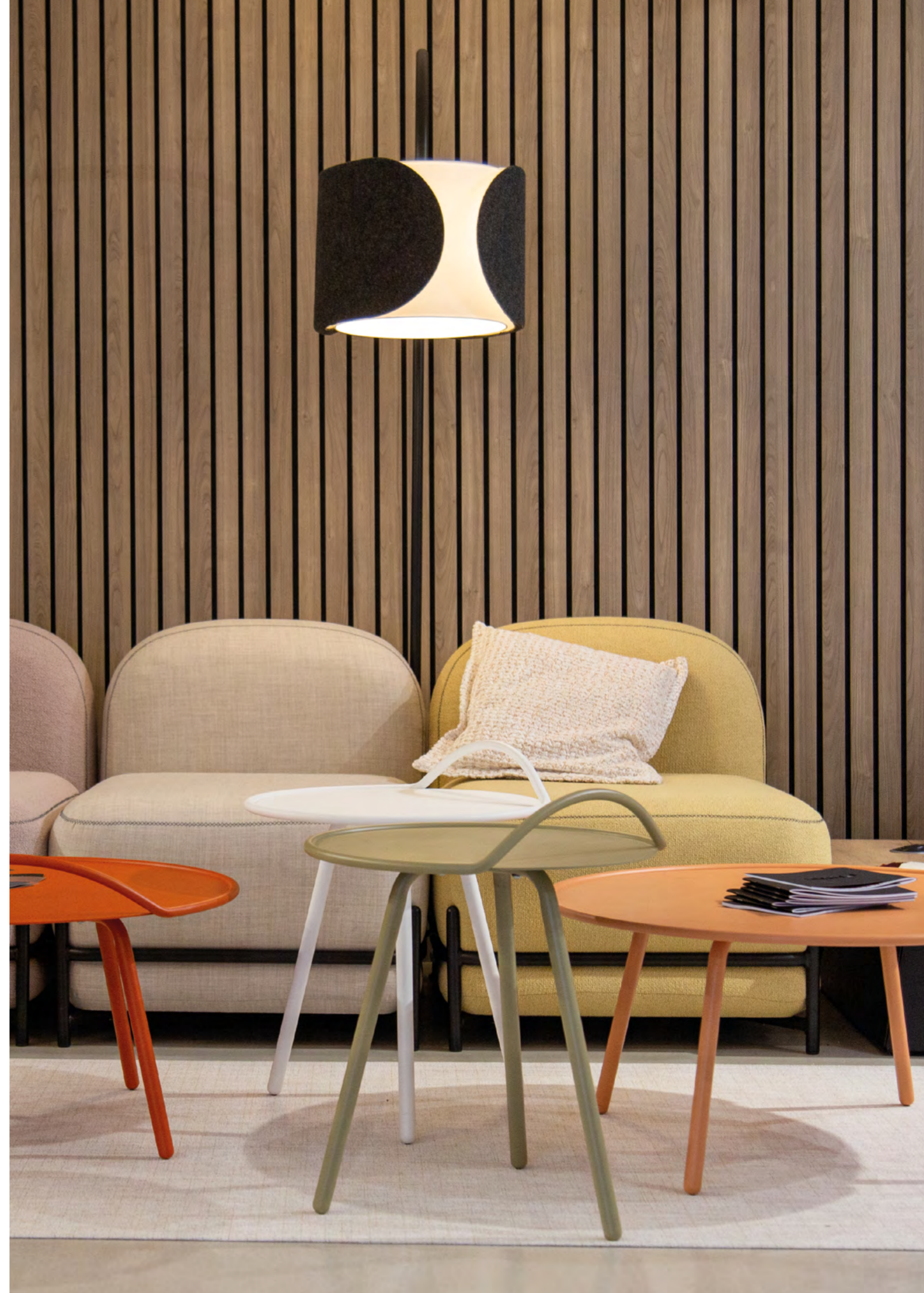



# ORBIT TABLE

---

With a unique design informed by the smooth curves and natural sleek lines of celestial orbits, this mid-century style coffee table is a fantastic and practical addition to any workspace. With a smaller recycled plastic table 'orbiting' and floating around the larger glass top, this table is timeless in its design and unrivalled in its functionality. Durable and hard-wearing, the Orbit table is designed to withstand the robust needs of any busy office environment.

## FEATURES

---

Mid Century T-frame design

Toughened glass (31.5")

Top made from recycled fridge freezer plastic (15.7")

Black frame finish



## STEPS TO SPECIFY

Follow our guide and customize our products to suit your space

1 2

Select Frame Finish: Available in Black only.

RAL metal frame finish



Black

1 2

Select Table Finish: Only available in the selected finishes.

Lower Table Top finish



Clear Glass

Upper Table Top finish



Recycled  
Plastic



### Orbit Table

width 32, depth 32, height 17, lower table height 12"

DESCRIPTION	ORDER CODE	PRICE
Table	OBL.BK	\$2,625



# WRAPT COFFEE TABLE

---

The Wrapt Coffee Table offers the ideal solution for any office looking to incorporate extra style without compromising practicality. Inspired by clean, simple lines, minimalism, and functionality without sacrificing beauty. With its generous tabletop area and clean wrap around leg design it is the perfect complement to the modern busy office, looking for a casual meeting space or breakout area.



## FEATURES

---

Simplistic Scandinavian design

Made from ash plywood

Available in three finishes



## STEPS TO SPECIFY

Follow our guide and customize our products to suit your space

1

Select Finish: Choose from selected finishes.

Wood frame finishes



Oak  
(Stained  
Ash)    Black Ash    Natural Ash



**Wrapt Coffee Table**  
diameter 36, height 13"

DESCRIPTION	ORDER CODE			PRICE
	Oak (Stained Ash)	Black Ash	Natural Ash	
Coffee Table	WTL.OCA	WTL.SBK	WTL.NAS	\$2,023

# OSTI CLOUD

---

This indoor and outdoor product is an extension of our existing Osti range with additional canopy to create a defined silhouette. The canopy incorporates separate mesh trays to allow you to accessorise with plants and lighting to create an inviting environment.



## FEATURES

---

- Designed for indoor or outdoor use
- Canopy offers space for lighting, plants & decoration
- UV and weather-resistant frames and surfaces
- Wide choice of frame finishes available
- Easy-clean design
- Delivered flat-pack for easy install
- Quick and easy to assemble



## STEPS TO SPECIFY

Follow our guide and customize our products to suit your space

1 2

Select Frame Finish: Choose from selected frame finishes

RAL metal frame finishes

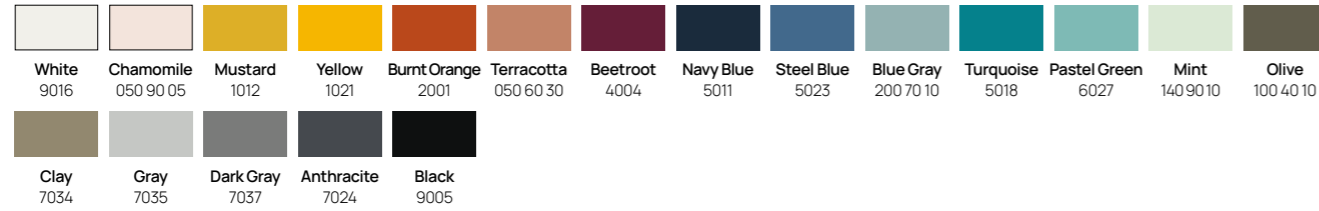

1 2

Select Accessories:



### Floor fixing plate

Supplied as a set of 4 black brackets per product.  
Floor fixing bolts are not supplied by Frövi.



### Osti Cloud

width 78.5, depth 45.5, height 78.5, table top height 29.5, table top depth 31.5"

DESCRIPTION	ORDER CODE	PRICE
Cloud	OSO	\$9,433

### Osti Accessories

DESCRIPTION	ORDER CODE	PRICE
Floor fixing plate set	OSFF	\$226
<small>Sold as a set of 4 black brackets per product. Floor fixing bolts are not supplied by Frövi.</small>		



# OSTI

---

Provide a space for collaborative working indoors, or position outdoors as the perfect addition to your outside space. Either option will bring style and practicality to any workspace.



## FEATURES

---

- Designed for indoor or outdoor use
- UV and weather-resistant
- Wide choice of frame finishes available
- Easy-clean design
- Delivered flat-pack for easy install
- Floor fixing option
- Quick and easy to assemble



STEPS TO SPECIFY

Follow our guide and customize our products to suit your space

- 1
- 2
- 3
- 4

Select Product: Table, Bar Height Table or Bench

- 1
- 2
- 3
- 4

Select Size

- 1
- 2
- 3
- 4

Select Frame Finish: Choose from selected frame finishes

RAL metal frame finishes

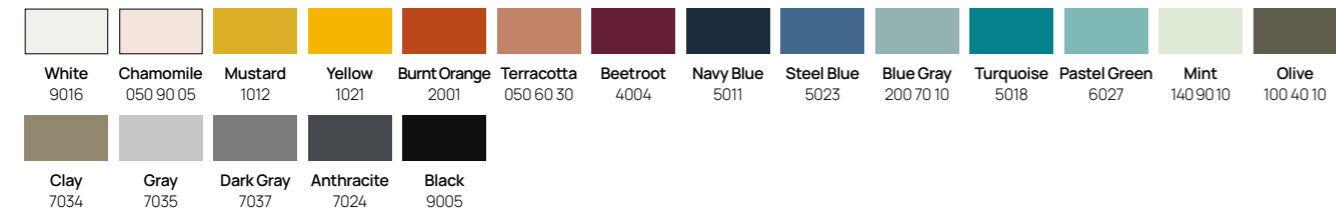

- 1
- 2
- 3
- 4

Select Accessories:



**Floor fixing plate**  
Supplied as a set of 4 black brackets per product. Floor fixing bolts are not supplied by Frövi.



**Osti Table**  
depth 45.5, height 29.5, table top depth 31.5"

WIDTH (Inch)	ORDER CODE	PRICE
Small - 63"	OST.160	\$5,045
Medium - 71"	OST.180	\$5,202
Large - 78.5"	OST.200	\$5,259



**Osti Bench** Sold as singles  
depth 22.5, height 20.5, seat height 16.5"

WIDTH (Inch)	ORDER CODE	PRICE
Small - 51"	OSB.140	\$2,404
Medium - 63"	OSB.160	\$2,454
Large - 71"	OSB.180	\$2,515



**Osti Bar Height Table**  
depth 49.5, height 41.5, table top depth 31.5"

WIDTH (Inch)	ORDER CODE	PRICE
Large - 78.5	OSP.200	\$5,825

**Osti Accessories**

DESCRIPTION	ORDER CODE	PRICE
Floor fixing plate set <small>Sold as a set of 4 black brackets per product. Floor fixing bolts are not supplied by Frövi</small>	OSFF	\$226



# FLORD TABLE

A range of minimalistic tables, simplistic designs to complement any breakout space.



## FEATURES

- Black frame finish
- Hard wearing steel frame
- Coffee Table available with Rustic or Fenix tops and optional power with integrated cable management

## STEPS TO SPECIFY

Follow our guide and customize our products to suit your space



Select Product



Select Top Finish: Coffee Table only  
Available with Rustic & Fenix Cutline edge tops, see page 303 for finish options.

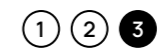

Select Power: Coffee Table only  
Solo Power Unit supplied with concealed cable management.



**Solo Power Unit**  
1x Power Outlet & 1x Twin USB Charge. (1x Type-C & 1x Type-A)  
Available in Black.

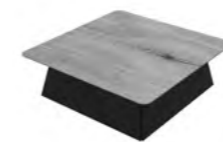

**Flord Coffee/Corner Table**  
width 38, depth 38, height 12"

DESCRIPTION	ORDER CODE	PRICE	
		Rustic	Fenix
Without Power	FFCT.BK.96S.NPR	\$2,840	\$3,136
With Power 1x Solo Power Unit	FFCT.BK.96S.SP1/BK	\$3,279	\$3,581



**Flord Side Table**  
width 14, depth 14, height 20"

DESCRIPTION	ORDER CODE	PRICE
	Black	
Side Table	FFST	\$865

# SLENDTA TABLE

---

A sleek simplistic table with tapered steel legs available with optional integrated power. This versatile design comes in a range of sizes and finishes, offering elegance and practicality, suitable for any location.



## FEATURES

---

- Two options of power - leg or surface mounted
- Integrated cable management
- Available in a range of frame and top finishes



STEPS TO SPECIFY

Follow our guide and customize our products to suit your space

- 1
- 2
- 3
- 4
- 5

Select Size

- 1
- 2
- 3
- 4
- 5

Select Power: Non-powered, power in leg or power in table top

Slendra Tables can be specified with or without integrated power. Power in Leg Tables are supplied with power in 2x left-end legs, on opposite corners. Power in Table Top are supplied with one steel lift-out power flap that matches the selected frame color.



Black Power modules in two legs  
1x Power Outlet &  
1x Twin USB Charge  
(1x Type-A & 1x Type-C)

Power tray and module finishes



Table Top Power Module Options

Option A

Includes: 4x Power Outlets & 2x Twin USB Charge (1x Type-C & 1x Type-A USB Charge)



Option B

Includes: 4x Power Outlets & 1x Twin USB Charge (1x Type-C & 1x Type-A USB Charge) & 1x HDMI



Option C

(- \$1,406 from RRP)

No power modules. Cable tray only for customers own power.



- 1
- 2
- 3
- 4
- 5

Select Frame Finish: RAL colored or Raw Steel

RAL metal frame finishes

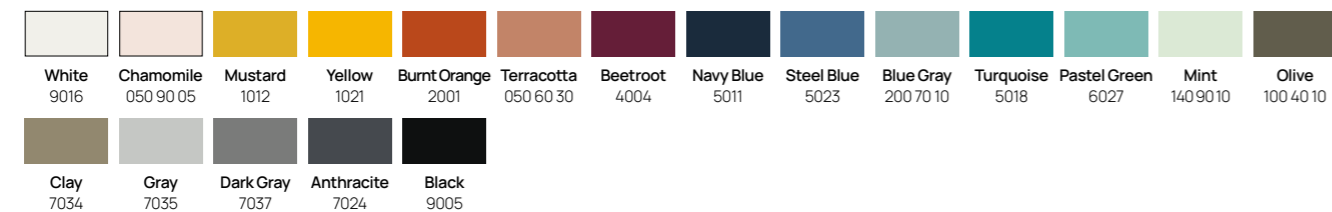

Metal frame finishes



- 1
- 2
- 3
- 4
- 5

Select Top Type and Finish:



Cutline edge  
top thickness 1"

Cutline Standard Laminat



Cutline Rustic

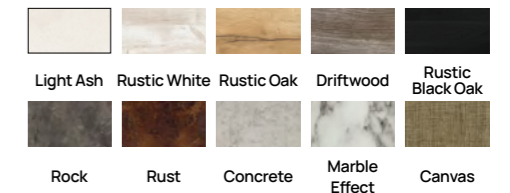

Cutline Fenix



- 1
- 2
- 3
- 4
- 5

Select Accessories

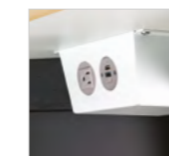

Discreet Power  
(See page 402 for more information)



**Slenda Table**  
height 29"

SIZE (Inch)	ORDER CODE	PRICE		
		Standard	Rustic	Fenix
	<b>Cutline Edge</b>			
	RAL/Raw			
71 x 31.5	STL.180.80	\$4,178	\$5,138	\$6,176
71 x 39.5	STL.180.100	\$4,377	\$5,263	\$6,231
71 x 47	STL.180.120	\$4,635	\$5,423	\$6,299
82.5 x 31.5	STL.210.80	\$4,455	\$5,302	\$6,244
82.5 x 39.5	STL.210.100	\$4,647	\$5,423	\$6,287
82.5 x 47	STL.210.120	\$4,909	\$5,580	\$6,344
94.5 x 31.5	STL.240.80	\$4,555	\$5,366	\$6,262
94.5 x 39.5	STL.240.100	\$4,747	\$5,486	\$6,311
94.5 x 47	STL.240.120	\$5,011	\$5,640	\$6,362



**Slenda Table with Power in Leg**  
height 29"

SIZE (Inch)	ORDER CODE	PRICE		
		Standard	Rustic	Fenix
	<b>Cutline Edge</b>			
	RAL/Raw			
71 x 31.5	STL.180.80.PWR/LEG	\$5,703	\$6,657	\$6,657
71 x 39.5	STL.180.100.PWR/LEG	\$5,900	\$6,778	\$6,778
71 x 47	STL.180.120.PWR/LEG	\$6,170	\$6,946	\$6,946
82.5 x 31.5	STL.210.80.PWR/LEG	\$5,986	\$6,827	\$6,827
82.5 x 39.5	STL.210.100.PWR/LEG	\$6,180	\$6,946	\$6,946
82.5 x 47	STL.210.120.PWR/LEG	\$6,444	\$7,104	\$7,104
94.5 x 31.5	STL.240.80.PWR/LEG	\$6,088	\$6,886	\$6,886
94.5 x 39.5	STL.240.100.PWR/LEG	\$6,285	\$7,009	\$7,009
94.5 x 47	STL.240.120.PWR/LEG	\$6,553	\$7,165	\$7,165



**Slenda Table with Power in Table Top**  
height 29"

SIZE (Inch)	ORDER CODE	PRICE		
		Standard	Rustic	Fenix
	<b>Cutline Edge</b>			
	RAL/Raw			
71 x 31.5	STL.180.80.WPV	\$5,440	\$6,400	\$7,438
71 x 39.5	STL.180.100.WPV	\$5,639	\$6,525	\$7,493
71 x 47	STL.180.120.WPV	\$5,897	\$6,685	\$7,561
82.5 x 31.5	STL.210.80.WPV	\$5,717	\$6,564	\$7,506
82.5 x 39.5	STL.210.100.WPV	\$5,909	\$6,685	\$7,549
82.5 x 47	STL.210.120.WPV	\$6,171	\$6,842	\$7,606
94.5 x 31.5	STL.240.80.WPV	\$5,817	\$6,628	\$7,524
94.5 x 39.5	STL.240.100.WPV	\$6,009	\$6,748	\$7,573
94.5 x 47	STL.240.120.WPV	\$6,273	\$6,902	\$7,624

Specify power module option - see page 302 for more information. Price includes cut-out/s in table top, power flap, cable tray and power modules.

Shroud and power flap in a contrasting finish to framework	RAL/Raw: +\$265	Vintage: +\$531	Custom cut-out	+ \$242
--	-----------------	-----------------	----------------	---------



# FOUNDRY GIANT

---

Manufactured from a re-purposed material, Foundry Giant has been designed with both sustainability and practicality at it's core. The strong, geometric rebar base is offered in a wide range of colors.



## FEATURES

---

- Recycled steel rebar frame
- Base supplied in three pieces for easy install
- Available in a wide range of frame and top finishes
- Large diameters available with or without power



STEPS TO SPECIFY

Follow our guide and customize our products to suit your space

- 1
- 2
- 3
- 4

Select Size: 70.8 or 82.6" diameter

- 1
- 2
- 3
- 4

Select Power: Non-powered or one/two trio power units



**Trio Power Unit**  
2x Power Outlet & 1x Twin USB Charge (1x Type-A & 1x Type-C)  
Available in Black  
Includes cable management.

- 1
- 2
- 3
- 4

Select Frame Finish: Raw finish is unavailable due to the nature of the material

RAL metal frame finishes

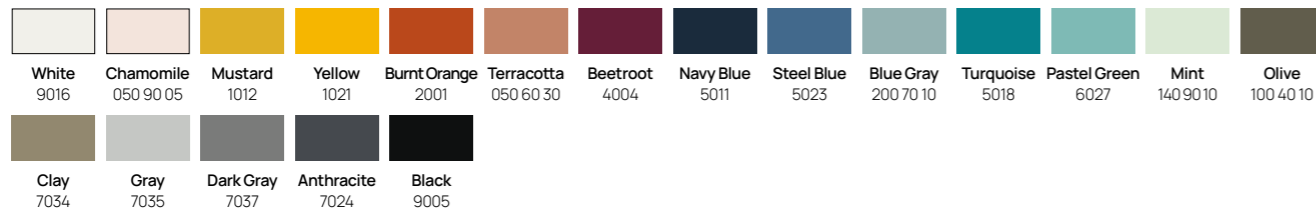

- 1
- 2
- 3
- 4

Select Top Finish:



**Cutline edge**  
top thickness 1"

Cutline Standard Laminate



Cutline Fenix



Cutline Rustic

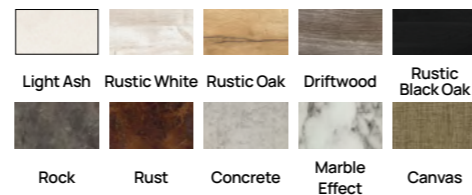

**Foundry Giant Table**  
height 29"

SIZE (Inch)	ORDER CODE	PRICE		
		Standard	Rustic	Fenix
71 dia	FDG.180D	\$10,037	\$11,826	\$13,469
82.5 dia	FDG.210D	\$11,989	\$12,814	\$14,542



**Foundry Giant Table with 1 Power**  
height 29"

SIZE (Inch)	ORDER CODE	PRICE		
		Standard	Rustic	Fenix
71 dia	FDG.180D.WPV/1PM	\$11,152	\$13,141	\$14,967
82.5 dia	FDG.210D.WPV/1PM	\$13,320	\$14,238	\$16,157



**Foundry Giant Table with 2 Power**  
height 29"

SIZE (Inch)	ORDER CODE	PRICE		
		Standard	Rustic	Fenix
71 dia	FDG.180D.WPV/2PM	\$12,265	\$14,455	\$16,462
82.5 dia	FDG.210D.WPV/2PM	\$14,656	\$15,662	\$17,774

Central metal strip in an alternative finish to framework RAL: +\$782

# MARGIN TABLE

---

Inspired by art deco sculptural design, this dual-height pair of circular nesting coffee tables fit into any location to add flair and warm residential feel. The low version is now available in a large 35.4" diameter.



## FEATURES

---

Available in a range of frame and top finishes

Available as a single table or a nesting pair

Easy to manoeuvre

Two sizes - 23.6 and 35.4"

Quick Ship available on selected variations and finishes, see pages 12 - 17 for more information.



STEPS TO SPECIFY

Follow our guide and customize our products to suit your space

- 1
- 2
- 3
- 4

Select Height: High or Low

- 1
- 2
- 3
- 4

Select Size: 23.6" or 35.4" diameter (Low height only)

- 1
- 2
- 3
- 4

Select Top Finish:

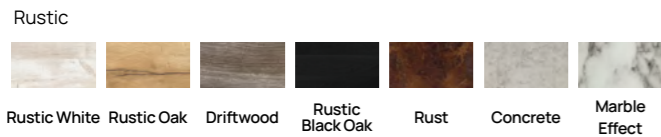

- 1
- 2
- 3
- 4

Select Frame Finish: RAL, Vintage or Raw Steel

RAL metal frame finishes

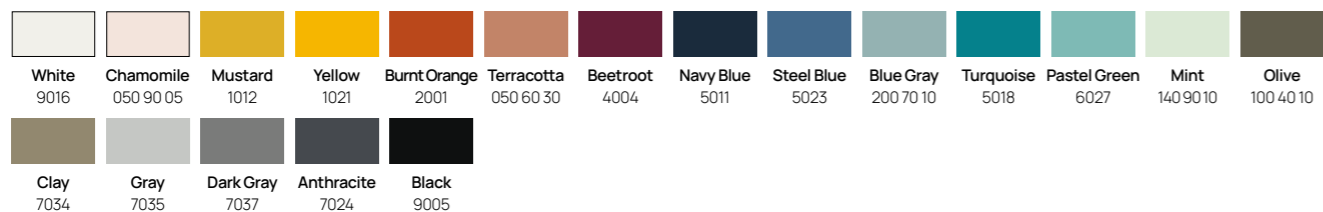

Vintage metal frame finishes



Metal frame finishes



**Margin Table High**  
height 17.5, top thickness 0.5"

TOP TYPE	SIZE (Inch)	ORDER CODE	PRICE	
			RAL/Raw	Vintage
MFC	23.5 dia	MTH.60D.45.M	\$1,508	\$2,213
Fenix/Rustic	23.5 dia	MTH.60D.45	\$1,888	\$2,611



**Margin Table Low**  
height 14, top thickness 0.5"

TOP TYPE	SIZE (Inch)	ORDER CODE	PRICE	
			RAL/Raw	Vintage
MFC	23.5 dia	MTL.60D.35.M	\$1,438	\$2,139
MFC	35.5 dia	MTL.90D.35.M	\$2,388	\$3,551
Fenix/Rustic	23.5 dia	MTL.60D.35	\$1,820	\$2,539
Fenix/Rustic	35.5 dia	MTL.90D.35	\$2,702	\$4,219



# MONO TABLE

---

The Mono Table has been designed to accommodate integrated cable management. It is perfectly weighted for optimal stability. With its wide range of sizes, Mono Table is great for use as a meeting table or in dining/breakout areas.



## FEATURES

---

Optional power with integrated cable management

Height adjustable levelling feet, designed to raise the base to neatly cover a standard floorbox

Available in a wide range of top sizes

Available in a wide range of finishes



STEPS TO SPECIFY

Follow our guide and customize our products to suit your space

- 1
- 2
- 3
- 4
- 5

Select Size

- 1
- 2
- 3
- 4

Select Power:

Solo Power Unit supplied with integrated cable management down central column.



**Solo Power Unit**  
1x Power Outlet & 1x Twin USB Charge. (1x Type-C & 1x Type-A)  
Available in Black or White

- 1
- 2
- 3
- 4

Select Top Type and Finish: Outline edge laminate or MFC



Cutline edge top thickness 1"

Cutline Standard Laminate

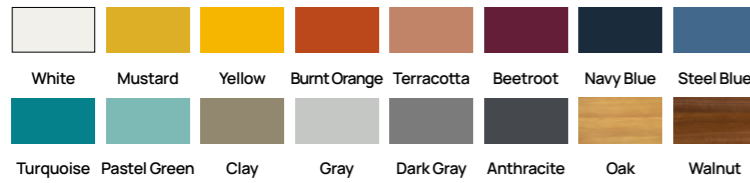

Cutline Fenix



Cutline Rustic

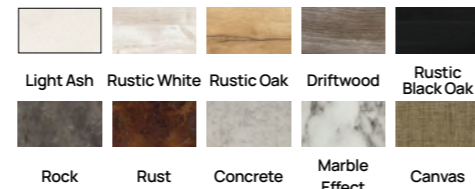

MFC top thickness 1"

MFC Finishes



- 1
- 2
- 3
- 4

Select Frame Finish: Colored or Raw Steel

RAL metal frame finishes

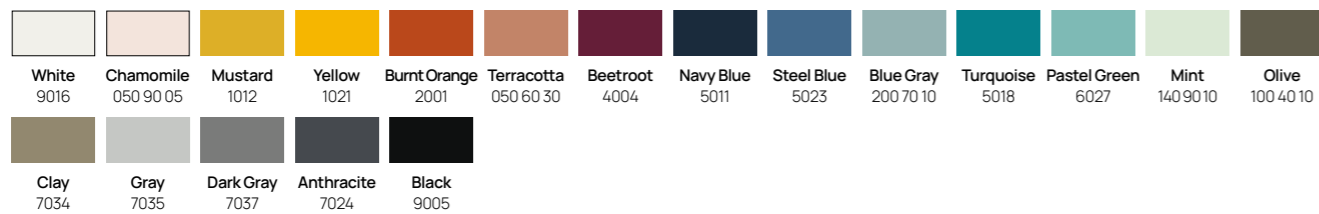

Metal frame finishes



**Mono Square Table**  
height 29"

TOP TYPE	SIZE (Inch)	ORDER CODE	PRICE		
			Standard	Rustic	Fenix
MFC	23.5 x 23.5	MPT.60S.DHT.M	\$1,661	-	-
	31.5 x 31.5	MPT.80S.DHT.M	\$1,842	-	-
Cutline	23.5 x 23.5	MPT.60S.DHT	\$2,216	\$2,762	\$3,590
	31.5 x 31.5	MPT.80S.DHT	\$2,369	\$2,939	\$3,721



**Mono Square Table with Power**  
height 29"

TOP TYPE	SIZE (Inch)	ORDER CODE	PRICE		
			Standard	Rustic	Fenix
MFC	23.5 x 23.5	MPT.60S.DHT.M.SP1	\$2,095	-	-
	31.5 x 31.5	MPT.80S.DHT.M.SP1	\$2,272	-	-
Cutline	23.5 x 23.5	MPT.60S.DHT.SP1	\$2,650	\$3,197	\$4,025
	31.5 x 31.5	MPT.80S.DHT.SP1	\$2,799	\$3,369	\$4,152



**Mono Rectangular Table**  
height 29"

TOP TYPE	SIZE (Inch)	ORDER CODE	PRICE		
			Standard	Rustic	Fenix
MFC	47 x 31.5	MPT.128R.DHT.M	\$2,063	-	-
	63 x 31.5	MPT.168R.DHT.M	\$3,494	-	-
	71 x 31.5	MPT.188R.DHT.M	\$3,607	-	-
Cutline	47 x 31.5	MPT.128R.DHT	\$2,806	\$3,083	\$3,874
	63 x 31.5	MPT.168R.DHT	\$4,326	\$4,892	\$5,668
	71 x 31.5	MPT.188R.DHT	\$5,008	\$5,157	\$6,044

63.0 x 31.5 and 70.9 x 31.5 tables come with 2 bases



**Mono Rectangular Table with Power**  
height 29"

TOP TYPE	SIZE (Inch)	ORDER CODE	PRICE		
			Standard	Rustic	Fenix
MFC	47 x 31.5	MPT.128R.DHT.M.SP1	\$2,493	-	-
	63 x 31.5	MPT.168R.DHT.M.SP1	\$4,363	-	-
	71 x 31.5	MPT.188R.DHT.M.SP1	\$4,477	-	-
Cutline	47 x 31.5	MPT.128R.DHT.SP1	\$3,236	\$3,513	\$4,304
	63 x 31.5	MPT.168R.DHT.SP1	\$5,196	\$5,762	\$6,538
	71 x 31.5	MPT.188R.DHT.SP1	\$5,878	\$6,026	\$6,913

63.0 x 31.5 and 70.9 x 31.5 tables come with 2 bases



**Mono Round Table**  
height 29"

TOP TYPE	SIZE (Inch)	ORDER CODE	PRICE		
			Standard	Rustic	Fenix
MFC	23.5 dia	MPT.60D.DHT.M	\$1,731	-	-
	31.5 dia	MPT.80D.DHT.M	\$1,800	-	-
	35.5 dia	MPT.90D.DHT.M	\$2,115	-	-
	39.5 dia	MPT.100D.DHT.M	\$2,213	-	-
	47 dia	MPT.120D.DHT.M	\$2,310	-	-
Cutline	23.5 dia	MPT.60D.DHT	\$2,091	\$2,733	\$3,590
	31.5 dia	MPT.80D.DHT	\$2,301	\$2,858	\$3,616
	35.5 dia	MPT.90D.DHT	\$2,467	\$2,985	\$3,721
	39.5 dia	MPT.100D.DHT	\$2,561	\$3,037	\$3,767
	47 dia	MPT.120D.DHT	\$2,653	\$3,138	\$3,784



**Mono Round Table with Power**  
height 29"

TOP TYPE	SIZE (Inch)	ORDER CODE	PRICE		
			Standard	Rustic	Fenix
MFC	23.5 dia	MPT.60D.DHT.M.SP1	\$2,165	-	-
	31.5 dia	MPT.80D.DHT.M.SP1	\$2,235	-	-
	35.5 dia	MPT.90D.DHT.M.SP1	\$2,546	-	-
	39.5 dia	MPT.100D.DHT.M.SP1	\$2,644	-	-
	47 dia	MPT.120D.DHT.M.SP1	\$2,740	-	-
Cutline	23.5 dia	MPT.60D.DHT.SP1	\$2,526	\$3,168	\$4,025
	31.5 dia	MPT.80D.DHT.SP1	\$2,736	\$3,293	\$4,051
	35.5 dia	MPT.90D.DHT.SP1	\$2,897	\$3,415	\$4,152
	39.5 dia	MPT.100D.DHT.SP1	\$2,991	\$3,468	\$4,197
	47 dia	MPT.120D.DHT.SP1	\$3,083	\$3,568	\$4,215

# MONO GIANT TABLE

With exceptional seating capacity, the Mono Giant Table has been designed to accommodate integrated cable management. It is perfectly weighted for optimal stability.



## FEATURES

- Large seating capacity
- Optional power with integrated cable management
- Base available in a wide range of finishes
- Height adjustable levelling feet, designed to raise the base to neatly cover a standard floorbox

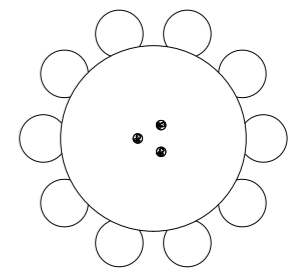

Seating configuration example (shown with Grow Stools)

## STEPS TO SPECIFY

Follow our guide and customize our products to suit your space

- 1 2 3

Select Frame Finish:  
Available with a Raw Steel or RAL color frame, see page 308 for finish options.

- 1 2 3

Select Top Finish:



- 1 2 3

Select Power: Non-powered or power with 3 x Solo Power Units  
See page 294 for more information.



**Mono Giant Table**  
height 29"

SIZE (Inch)	ORDER CODE	PRICE
63 dia	MPG.160D	\$4,844
71 dia	MPG.180D	\$5,718



**Mono Giant Table with Power (3 x Solo Power Units)**  
height 29"

SIZE (Inch)	ORDER CODE	PRICE
63 dia	MPG.160D.SPG1	\$6,321
71 dia	MPG.180D.SPG1	\$7,195

# YAK COFFEE TABLE

---

Designed to perfectly complement our Yak chairs, this coffee table also works well with any wood framed seating. Yak Coffee Table brings the warmth of natural timber to your space.



## FEATURES

---

- Frames beautifully hand crafted from solid wood
- Designed to co-ordinate with other timber products
- Solid Oak or Black Oak frame



STEPS TO SPECIFY

Follow our guide and customize our products to suit your space

1 2 3

Select Size

1 2 3

Select Top Type and Finish: Cutline edge laminate or MFC



Cutline edge top thickness 1"

Cutline Standard Laminate



Cutline Rustic

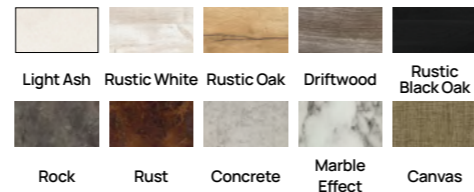

Cutline Fenix



MFC top thickness 1"

MFC Finishes



1 2 3

Select Frame Finish: Choose from selected finishes

Wood frame finishes



Natural Oak Black Oak



**Yak Round Coffee Table**  
height 15.5"

TOP TYPE	SIZE (Inch)	ORDER CODE	PRICE		
			Standard	Rustic	Fenix
MFC	23.5 dia	YKL.60D.M	\$1,394	-	-
	31.5 dia	YKL.80D.M	\$1,464	-	-
	35.5 dia	YKL.90D.M	\$1,685	-	-
Cutline	31.5 dia	YKL.80D	\$1,964	\$2,521	\$3,280
	35.5 dia	YKL.90D	\$2,036	\$2,554	\$3,291



**Yak Square Coffee Table**  
height 15.5"

TOP TYPE	SIZE (Inch)	ORDER CODE	PRICE		
			Standard	Rustic	Fenix
MFC	23.5 x 23.5	YKL.60S.M	\$1,324	-	-
	31.5 x 31.5	YKL.80S.M	\$1,412	-	-
Cutline	23.5 x 23.5	YKL.60S	\$1,879	\$2,425	\$3,253
	31.5 x 31.5	YKL.80S	\$1,938	\$2,508	\$3,291



**Yak Rectangular Coffee Table**  
height 15.5"

TOP TYPE	SIZE (Inch)	ORDER CODE	PRICE		
			Standard	Rustic	Fenix
MFC	39.5 x 23.5	YKL.106R.M	\$1,407	-	-
	47 x 31.5	YKL.128R.M	\$1,632	-	-
Cutline	39.5 x 23.5	YKL.106R	\$1,947	\$2,535	\$3,319
	47 x 31.5	YKL.128R	\$2,375	\$2,653	\$3,444

# WIRE COFFEE TABLE

---

Engineered to give you a clean aesthetic, this timeless design is available in a wide range of top colors and finishes.



## FEATURES

---

- Simplistic design
- Perfectly complements our existing ranges
- Large range of color combinations
- Black frame finish



STEPS TO SPECIFY

Follow our guide and customize our products to suit your space

1 2 3

Select Size

1 2 3

Select Top Type and Finish: Outline edge laminate or MFC



Cutline Standard Laminate



Cutline Fenix



Cutline Rustic

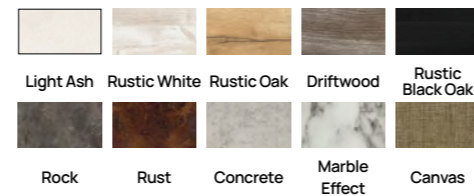

MFC Finishes



1 2 3

Select Frame Finish: Choose from selected finishes

RAL metal frame finishes

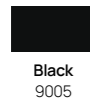

Wire Round Coffee Table  
height 16.5"

TOP TYPE	SIZE (Inch)	ORDER CODE	PRICE		
			Standard	Rustic	Fenix
		<b>Top Finish:</b>			
MFC	23.5 dia	WRL.60D.M	\$924	-	-
	31.5 dia	WRL.80D.M	\$994	-	-
Cutline	23.5 dia	WRL.60D	\$1,285	\$1,927	\$2,784
	31.5 dia	WRL.80D	\$1,495	\$2,052	\$2,810



Wire Rectangular Coffee Table  
height 16.5"

TOP TYPE	SIZE (Inch)	ORDER CODE	PRICE		
			Standard	Rustic	Fenix
		<b>Top Finish:</b>			
MFC	39.5 x 23.5	WRL.106R.M	\$937	-	-
Cutline	39.5 x 23.5	WRL.106R	\$1,477	\$2,065	\$2,849

# LAPTOP TABLE

This simple yet effective laptop table is ideal where space is at a premium. It's compact and practical, ideal for agile working.



## FEATURES

- Gliders to enable easy movement on all floor surfaces
- Hard wearing steel frame
- Sturdy construction

## STEPS TO SPECIFY

Follow our guide and customize our products to suit your space

1

Select Frame Finish: Black RAL or Raw Steel

RAL metal frame finish



Black  
9005

Metal frame finish

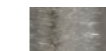

Clear  
coated  
raw steel  
**Raw Steel**



### Laptop Table

width 16.5, depth 19.5, height 26.5"

DESCRIPTION	ORDER CODE	PRICE
Laptop Table	LTT	\$1,283



# Outdoor

OSTI  
OSTI CLOUD  
VECK

358  
354  
362



# OSTI CLOUD

---

This indoor and outdoor product is an extension of our existing Osti range with additional canopy to create a defined silhouette. The canopy incorporates separate mesh trays to allow you to accessorise with plants and lighting to create an inviting environment.



## FEATURES

---

- Designed for indoor or outdoor use
- Canopy offers space for lighting, plants & decoration
- UV and weather-resistant frames and surfaces
- Wide choice of frame finishes available
- Easy-clean design
- Delivered flat-pack for easy install
- Quick and easy to assemble



## STEPS TO SPECIFY

Follow our guide and customize our products to suit your space

1 2

Select Frame Finish: Choose from selected frame finishes

RAL metal frame finishes

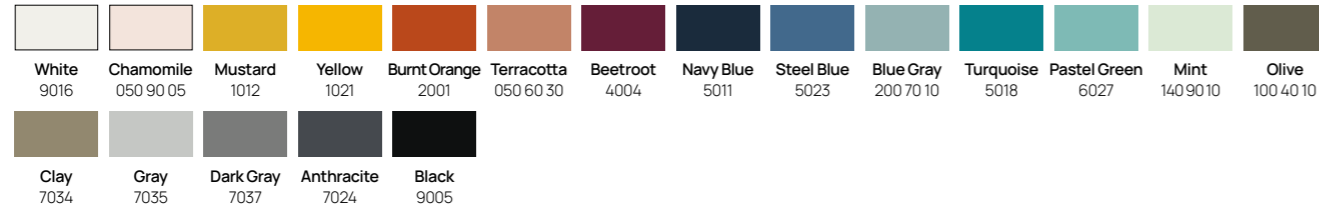

1 2

Select Accessories:



### Floor fixing plate

Supplied as a set of 4 black brackets per product.  
Floor fixing bolts are not supplied by Frövi.



### Osti Cloud

width 78.5, depth 45.5, height 78.5, table top height 29.5, table top depth 31.5"

DESCRIPTION	ORDER CODE	PRICE
Cloud	OSO	\$9,433

### Osti Accessories

DESCRIPTION	ORDER CODE	PRICE
Floor fixing plate set	OSFF	\$226
Sold as a set of 4 black brackets per product. Floor fixing bolts are not supplied by Frövi.		



# OSTI

---

Provide a space for collaborative working indoors, or position outdoors as the perfect addition to your outside space. Either option will bring style and practicality to any workspace.



## FEATURES

---

- Designed for indoor or outdoor use
- UV and weather-resistant
- Wide choice of frame finishes available
- Easy-clean design
- Delivered flat-pack for easy install
- Floor fixing option
- Quick and easy to assemble



STEPS TO SPECIFY

Follow our guide and customize our products to suit your space

- 1
- 2
- 3
- 4

Select Product: Table, Bar Height Table or Bench

- 1
- 2
- 3
- 4

Select Size

- 1
- 2
- 3
- 4

Select Frame Finish: Choose from selected frame finishes

RAL metal frame finishes

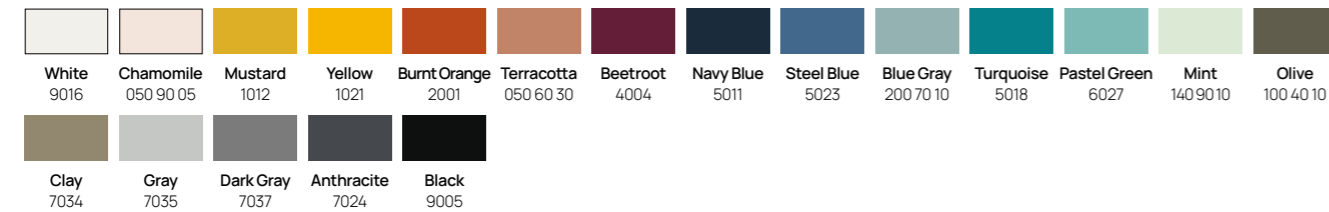

- 1
- 2
- 3
- 4

Select Accessories:



**Floor fixing plate**

Supplied as a set of 4 black brackets per product.  
Floor fixing bolts are not supplied by Frövi.



**Osti Table**  
depth 45.5, height 29.5, table top depth 31.5"

WIDTH (Inch)	ORDER CODE	PRICE
Small - 63"	OST.160	\$5,045
Medium - 71"	OST.180	\$5,202
Large - 78.5"	OST.200	\$5,259



**Osti Bench** Sold as singles  
depth 22.5, height 20.5, seat height 16.5"

WIDTH (Inch)	ORDER CODE	PRICE
Small - 55"	OSB.140	\$2,404
Medium - 63"	OSB.160	\$2,454
Large - 71"	OSB.180	\$2,515



**Osti Bar Height Table**  
depth 49.5, height 41.5, table top depth 31.5"

WIDTH (Inch)	ORDER CODE	PRICE
Large - 78.5"	OSP.200	\$5,825

**Osti Accessories**

DESCRIPTION	ORDER CODE	PRICE
Floor fixing plate set <small>Sold as a set of 4 black brackets per product. Floor fixing bolts are not supplied by Frövi</small>	OSFF	\$226

# VECK

---

Veck is a versatile, lightweight tubular framed stool, with a unique triangular punched, patterned seat - perfect for use indoors or outdoors. Available as a High, Counter-height or Low Stool with upholstered seat pad options.



## FEATURES

---

Suitable for indoor or outdoor use

Removable upholstered seat pad

Seat pads available in outdoor suitable fabric - See pages 406 - 415

Wide choice of frame finishes available

Available in 3 seat heights

Stackable up to 4 high



STEPS TO SPECIFY

Follow our guide and customize our products to suit your space

1 2 3

Select Height: Low, Medium or High Stool

1 2 3

Select Frame Finish: Choose from selected frame finishes

RAL metal frame finishes

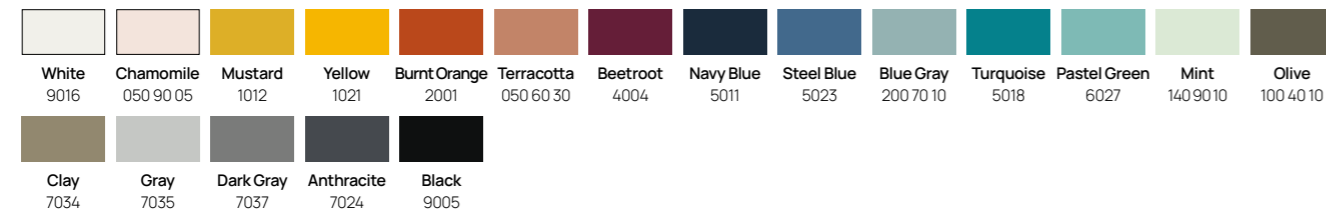

1 2 3

Select Accessories:



Triple Quilted Seat Pad

(Available in fabric bands 1-8 - See pages 406 - 415)



**Veck Low Stool**  
width 21.5, depth 22, height 22, seat height 18.5"

DESCRIPTION	ORDER CODE	PRICE
Metal	VKS.LHT	\$614



**Veck Medium Stool (Counter-height)**  
width 21.5, depth 22, height 29.5, seat height 25.5"

DESCRIPTION	ORDER CODE	PRICE
Metal	VKS.MHT	\$676



**Veck High Stool**  
width 21.5, depth 23, height 35, seat height 31"

DESCRIPTION	ORDER CODE	PRICE
Metal	VKS.HHT	\$716

**Veck Upholstered Seat Pad (select from outdoor fabrics)**

FABRIC	ORDER CODE	PRICE
	Triple Quilted	
1	VKS-I.LHT.WSP/U.FBB	\$227
2	VKS-I.LHT.WSP/U.FBC	\$242
3	VKS-I.LHT.WSP/U.FBD	\$264
4	VKS-I.LHT.WSP/U.FBE	\$291
5	VKS-I.LHT.WSP/U.FBF	\$319
6	VKS-I.LHT.WSP/U.FBG	\$375
7	VKS-I.LHT.WSP/U.FBH	\$432
8	VKS-I.LHT.WSP/U.FBI	\$493

For Veck Indoor, see page 238.

# Accessories

CUSHIONS  
HOME MOBILE MEDIA WALL

372  
368





# HOME MOBILE MEDIA WALL

---

Perfect addition to our Home range, this mobile media wall offers a flexible approach for workspaces and learning environments. A truly mobile piece allowing users to manoeuvre into position when and where required.



## FEATURES

---

- Fully mobile, easy to manoeuvre with braking castors
- Cable management as standard
- Extensive range of accessories including power and monitor mount
- Dual purpose - can use both sides



For the full Home collection, see page 172.

STEPS TO SPECIFY

Follow our guide and customize our products to suit your space

1 2 3

Select Height: Standard or Bar height

1 2 3

Select Fabric: Available in fabric grades 1-8

Fabrics  
See pages 406-415

1 2 3

Choose Additional Extras:

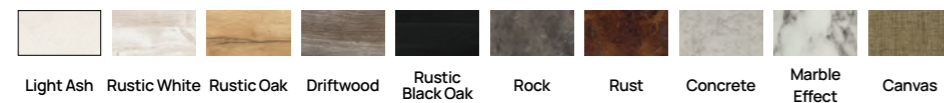

Table  
Available with outline edge top finishes.

Cutline Standard Laminate



Cutline Rustic



Cutline Fenix

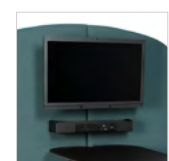

Monitor Mount



Power Shelf



White Board

Each Power Shelf includes:

2x Power Outlet, 1x Twin USB (1x Type-A & 1x Type-C) & 1x HDMI as standard with concealed additional power for a monitor. Monitors are not supplied by Frövi and a 28 inch screen size is recommended. Cable management in upholstery.



Home Mobile Media Wall  
width 60, depth 18.5, height 56.5, panel depth 2"

FABRIC	ORDER CODE	PRICE
1	HOMW.SHT.BK.FBB	\$3,044
2	HOMW.SHT.BK.FBC	\$3,214
3	HOMW.SHT.BK.FBD	\$3,384
4	HOMW.SHT.BK.FBE	\$3,642
5	HOMW.SHT.BK.FBF	\$3,898
6	HOMW.SHT.BK.FBG	\$4,409
7	HOMW.SHT.BK.FBH	\$4,917
8	HOMW.SHT.BK.FBI	\$5,431



Home Bar Height Mobile Media Wall  
width 60, depth 18.5, height 68.5, panel depth 2"

FABRIC	ORDER CODE	PRICE
1	HOMW.PHT.BK.FBB	\$3,044
2	HOMW.PHT.BK.FBC	\$3,214
3	HOMW.PHT.BK.FBD	\$3,384
4	HOMW.PHT.BK.FBE	\$3,642
5	HOMW.PHT.BK.FBF	\$3,898
6	HOMW.PHT.BK.FBG	\$4,409
7	HOMW.PHT.BK.FBH	\$4,917
8	HOMW.PHT.BK.FBI	\$5,431

DESCRIPTION	ORDER CODE	PRICE
Mobile Media Wall Accessories		Standard Rustic Fenix
Table Standard table height for mobile media wall only	HOTT.BK	\$1,126 \$1,928 \$2,727
Power Shelf	HOPS.HO/2UK/TU/H/BK	\$606
White board	HOWB	\$542
Monitor Mount	HOMM	\$182

For the full Home collection, see page 172.

# CUSHIONS



## FEATURES

- Can be upholstered in any contract fabric
- Fire retardant fillings for contract use
- Available in three sizes

## STEPS TO SPECIFY

Follow our guide and customize our products to suit your space

**1**

Select Fabric: Available in fabric grades 1-8

Fabrics  
See pages 406-415

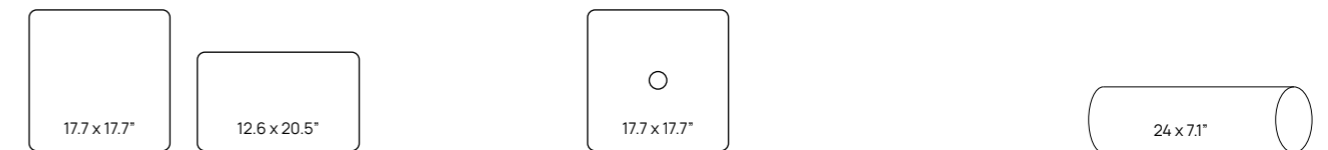

## Cushions

FABRIC	Without buttons		PRICE	With matching buttons		PRICE	With contrasting buttons		PRICE
	17.5 x 17.5"	20.5 x 12.5"		17.5 x 17.5"	17.5 x 17.5"		24 x 7"		
1	CUN.4545.CUNB.FBB	CUN.5232.CUNB.FBB	\$282	CUN.4545.CUMB.FBB	CUN.4545.CUCB.FBB	\$341	CUN.6118.CUNB.FBB		\$367
2	CUN.4545.CUNB.FBC	CUN.5232.CUNB.FBC	\$302	CUN.4545.CUMB.FBC	CUN.4545.CUCB.FBC	\$365	CUN.6118.CUNB.FBC		\$387
3	CUN.4545.CUNB.FBD	CUN.5232.CUNB.FBD	\$326	CUN.4545.CUMB.FBD	CUN.4545.CUCB.FBD	\$387	CUN.6118.CUNB.FBD		\$411
4	CUN.4545.CUNB.FBE	CUN.5232.CUNB.FBE	\$363	CUN.4545.CUMB.FBE	CUN.4545.CUCB.FBE	\$422	CUN.6118.CUNB.FBE		\$444
5	CUN.4545.CUNB.FBF	CUN.5232.CUNB.FBF	\$393	CUN.4545.CUMB.FBF	CUN.4545.CUCB.FBF	\$457	CUN.6118.CUNB.FBF		\$474
6	CUN.4545.CUNB.FBG	CUN.5232.CUNB.FBG	\$465	CUN.4545.CUMB.FBG	CUN.4545.CUCB.FBG	\$524	CUN.6118.CUNB.FBG		\$538
7	CUN.4545.CUNB.FBH	CUN.5232.CUNB.FBH	\$535	CUN.4545.CUMB.FBH	CUN.4545.CUCB.FBH	\$590	CUN.6118.CUNB.FBH		\$603
8	CUN.4545.CUNB.FBI	CUN.5232.CUNB.FBI	\$605	CUN.4545.CUMB.FBI	CUN.4545.CUCB.FBI	\$664	CUN.6118.CUNB.FBI		\$669

# Shelving & Storage

BAMBOO	376
FOUNDRY	396
JIG CREDENZA	392
RELIC CREDENZA	388



# bamboo®

We've taken our responsibility for sustainable design and production one step further. Crafted from recycled ocean plastic, recycled PET Felt, and pressed bamboo our Bamboo range has been designed with our planet in mind. Available in straight and curved shelving options means style meets sustainability. Our curved shelving option is a response to the emerging popularity of a more organic and fluid style of landscape within the workplace and can be used to create spaces alongside curved curtain walls and soft lounge-style seating. Create your own design using our online Bamboo configuration tool.



## FEATURES

Bamboo is a carbon negative material and the use of bamboo products can help achieve a higher certification level for LEED and BREEAM

Configurable for any workspace

Easy and quick to assemble, supplied with tools for quick install

100% recycled ocean plastic connectors

Framework available in any of our RAL colors

All shelves, cupboards & lockers made from side-pressed bamboo

Incorporate biophilia with integrated and mobile planters

Felt panel for pinboard use, made from a blend of 70% recycled and 30% virgin PET

Packaging is made from 100% recyclable cardboard, made from 80% recycled material

Height adjustable feet

Mobile table for agile working

Lamp to fit any configuration

Award-winning - Best of NeoCon Gold Award 2022

Quick Ship available on selected variations and finishes, see pages 12 - 17 for more information.



Scan to watch videos and find out more

 CONFIGURE

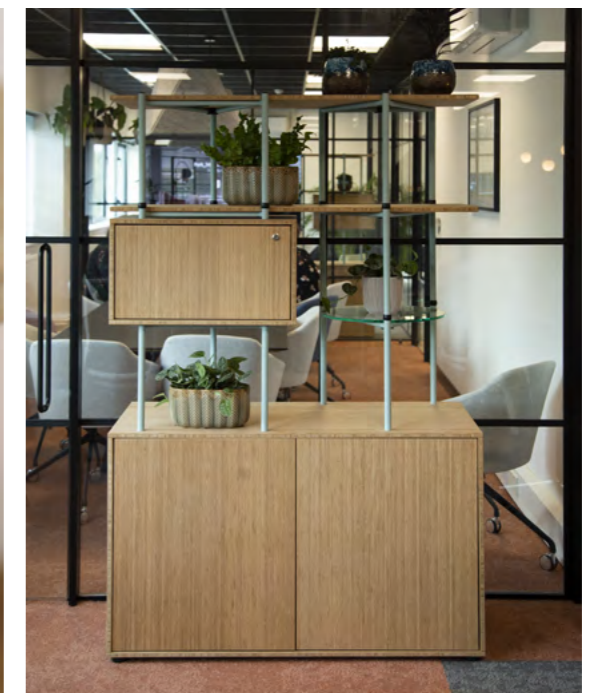





Felt Panel



Recycled ocean plastic connectors



Integrated and mobile planters



Storage Locker

Open Acrylic Back Unit



CONFIGURE YOUR OWN DESIGN ONLINE

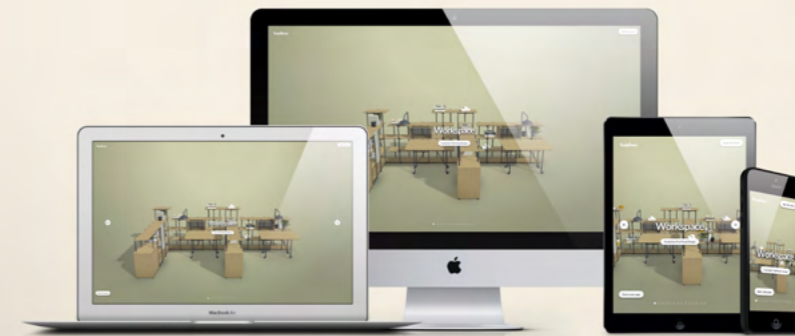

Use our online configurator at [frovidesign.com/bamboo](https://frovidesign.com/bamboo) to help you customise our presets or specify your own custom Bamboo configuration.

 CONFIGURE



# bamboo | environmentally conscious

Our Bamboo range has been created by our environmentally conscious in-house design team, where possible we have opted to use the most eco-friendly and low impact materials. This year, we've taken further steps towards a more sustainable future. It starts with the launch of our Bamboo collection, a range that uses environmentally conscious materials and processes. All our shelves, cupboards, storage boxes and tabletops in the range are made from bamboo. This material is widely known for being extremely sustainable hard wood alternative - it has a negative carbon footprint!



**bamboo uses  
1/3 of the water  
consumption to  
grow than oak**

## sustainable buildings

The use of bamboo products can help achieve a higher certification level for LEED and BREEAM. It can also help achieve more points towards the building becoming WELL-aligned.



## one of the fastest growing plants

It only takes a year to grow back after it's been harvested. Some species grow more than 3 feet (1 meter) each day.



**bamboo uses  
no pesticides or  
chemical fertilisers**

## clean air

Bamboo releases 30% more oxygen than hardwoods and it absorbs 5 times more carbon dioxide than standard trees.



## low energy powder coating

Our specially designed powder coatings are cured at lower oven temperatures, which reduces energy usage and waste generation, lowering our overall carbon footprint.



## anti-bacterial

Bamboo has the ability to withstand and kill bacteria. It is also very easy to clean.



BASIC CONFIGURATION EXAMPLES

Visit [frovidesign.com/bamboo](http://frovidesign.com/bamboo) to configure your own



**Bamboo 5 High - 47"**  
width 47, depth 17, height 74"

DESCRIPTION	ORDER CODE	PRICE
47"	BAM.512.ST	\$4,723



**Bamboo 5 High - 71"**  
width 71, depth 17.5, height 74"

DESCRIPTION	ORDER CODE	PRICE
71"	BAM.518.ST	\$7,360



**Bamboo 2 High Planter**  
width 47, depth 17.5, height 37"

DESCRIPTION	ORDER CODE	PRICE
Planter	BAM-P512.ST	\$7,456

includes 2 trays & 8 planters



**Bamboo 2 High Planter on Castors**  
width 47, depth 17.5, height 37"

DESCRIPTION	ORDER CODE	PRICE
Planter on Castors	BAM-MP512.ST	\$7,967

includes 2 trays & 8 planters



**Bamboo 5 High Double Cupboard**  
width 47, depth 18.5, height 74"

DESCRIPTION	ORDER CODE	PRICE
Double Cupboard	BAM.512.CB2/	\$6,103



**Bamboo 5 High Corner (Overlapping)**  
width 47, depth 47, height 74"

DESCRIPTION	ORDER CODE	PRICE
Corner	BAM.512.L/	\$7,577



**Bamboo Mobile Table**  
width 47, depth 31.5, height 29"

DESCRIPTION	ORDER CODE	PRICE
Table	BAM-MT.AN.128R.NBA	\$1,582



**Bamboo Planter**  
width 23.5-47, depth 14.5, height 6"

DESCRIPTION	ORDER CODE	PRICE
23.5" - includes 1 tray & 2 planters	BAM-P.SBP	\$1,981
47" - includes 1 trays & 4 planters	BAM-P.DBP	\$3,027



**Bamboo Freestanding Single Cupboard**  
width 23.5, depth 18.5, height 30"

DESCRIPTION	ORDER CODE	PRICE
Freestanding Single Cupboard	BAM-CB.SFCS/	\$1,892



**Bamboo Freestanding Double Cupboard**  
width 47, depth 18.5, height 30"

DESCRIPTION	ORDER CODE	PRICE
Freestanding Double Cupboard	BAM-CB.SFCD/	\$3,768



**Bamboo Felt Panel**  
width 14, depth 0.5, height 31.5"

DESCRIPTION	ORDER CODE	PRICE
Felt Panel	BAM-FP	\$232



Selected Bamboo products in selected colors are available on Quick Ship, see pages 12 - 17 for more information.

BASIC CONFIGURATION EXAMPLES

Visit [frovidesign.com/bamboo](http://frovidesign.com/bamboo) to configure your own



**Curved Bamboo 2 High - 90 Degree**  
width 45.5, depth 21, height 30"

DESCRIPTION	ORDER CODE	PRICE
2 High	BAM.2.45R.90DEG.CU	\$2,821



**Curved Bamboo 3 High - 90 Degree**  
width 45.5, depth 21, height 43.5"

DESCRIPTION	ORDER CODE	PRICE
3 High	BAM.3.45R.90DEG.CU	\$3,711



**Curved Bamboo 4 High - 90 Degree**  
width 45.5, depth 21, height 58"

DESCRIPTION	ORDER CODE	PRICE
4 High	BAM.4.45R.90DEG.CU	\$4,602



**Curved Bamboo 5 High - 90 Degree**  
width 45.5, depth 21, height 73"

DESCRIPTION	ORDER CODE	PRICE
5 High	BAM.5.45R.90DEG.CU	\$5,492



**Curved Bamboo 2 High - 36 Degree**  
width 52.5, depth 19, height 29"

DESCRIPTION	ORDER CODE	PRICE
2 High	BAM.2.180R.36DEG.CU	\$2,821



**Curved Bamboo 3 High - 36 Degree**  
width 52.5, depth 19, height 29"

DESCRIPTION	ORDER CODE	PRICE
3 High	BAM.3.180R.36DEG.CU	\$3,711



**Curved Bamboo 4 High - 36 Degree**  
width 52.5, depth 19, height 29"

DESCRIPTION	ORDER CODE	PRICE
4 High	BAM.4.180R.36DEG.CU	\$4,602



**Curved Bamboo 5 High - 36 Degree**  
width 52.5, depth 19, height 29"

DESCRIPTION	ORDER CODE	PRICE
5 High	BAM.5.180R.36DEG.CU	\$5,492



**Cupboard and Curve Configuration** Double Cupboard and 5 High - 90 Degree  
width 81.5" depth 34.5" height 72"

DESCRIPTION	ORDER CODE	PRICE
Double Cupboard		\$11,595



**'S' Shape Configuration** 3 High - 36 Degree and 5 High - 36 Degree  
width 92" depth 47.5" height 72"

DESCRIPTION	ORDER CODE	PRICE
3 & 5 High		\$9,203



**Large Curve Configuration** 2 x 3 High - 36 Degree High  
width 81.5" depth 65" height 43.5"

DESCRIPTION	ORDER CODE	PRICE
2 x 3 High		\$7,422

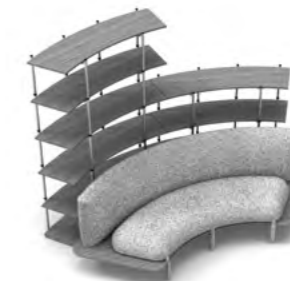

**Bamboo and Bae Configuration** 5 High - 36 Degree, 3 High - 36 Degree and 90 Degree Inwards  
width 92" depth 65" height 43.5"

DESCRIPTION	ORDER CODE	PRICE
5 & 3 High		\$18,469

# RELIC CREDENZA

---

Designed to complement the popular Relic table range. The Relic Credenza is a less formal option to traditional storage.



## FEATURES

---

Available in a wide range of finishes

Push to open doors

Available in two heights



STEPS TO SPECIFY

Follow our step-by-step guide and customize our products to suit your space

- 1
- 2
- 3
- 4

Select Height: High or Low

- 1
- 2
- 3
- 4

Select Frame Finish:

Metal frame finishes

Relic Credenza



RAL metal frame finishes

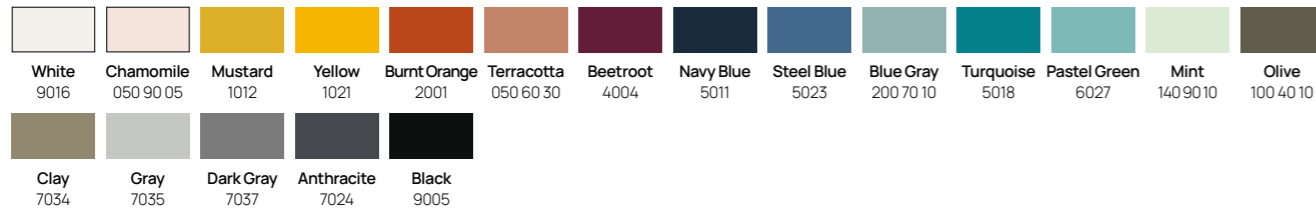

Vintage metal frame finishes



Metal frame finishes



- 1
- 2
- 3
- 4

Select Cabinet Finish:

Cabinet finishes



- 1
- 2
- 3
- 4

Select Door Finish:

Door finishes

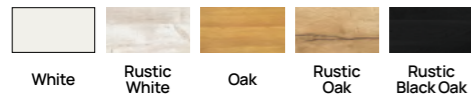

**Relic Credenza Low**  
width 74.5, depth 18.5, height 25"

DESCRIPTION	ORDER CODE	PRICE	
		RAL/Raw	Vintage
Relic Frame	RZZ.LL	\$7,744	\$8,351



**Relic Credenza High**  
width 74.5, depth 18.5, height 28.5"

DESCRIPTION	ORDER CODE	PRICE	
		RAL/Raw	Vintage
Relic Frame	RZZ.HH	\$8,513	\$9,149
includes removable shelf			

# JIG CREDENZA

---

This stylish design offers a perfect storage solution. Used together with timber products, the Jig Credenza adds the finishing touch. The perfect addition for when storage space comes at a premium.



## FEATURES

---

Available in a range of finishes

Push-to-open

Available in two heights



STEPS TO SPECIFY

Follow our guide and customize our products to suit your space

- 1
- 2
- 3
- 4

Select Height: High or Low

- 1
- 2
- 3
- 4

Select Frame Finish:

Wood frame finishes  
Jig Credenza



Natural Oak Black Oak

- 1
- 2
- 3
- 4

Select Cabinet Finish:

Cabinet finishes



Rustic White Oak Rustic Oak Rustic Black Oak

- 1
- 2
- 3
- 4

Select Door Finish:

Door finishes



White Rustic White Oak Rustic Oak Rustic Black Oak



**Jig Credenza Low**  
width 72.5, depth 18.5, height 25"

DESCRIPTION	ORDER CODE	PRICE
	Push-to-open	
Jig Frame	JZZ.LL.PTO	\$5,954



**Jig Credenza High**  
width 72.5, depth 18.5, height 28.5"

DESCRIPTION	ORDER CODE	PRICE
	Push-to-open	
Jig Frame	JZZ.HH.PTO	\$6,538

includes removable shelf

# FOUNDRY

---

Providing contrast between the beauty of wood and raw industrial characteristics of Rebar; the Foundry range offers a unique shelving solution. The use of alternative materials such as Rebar within the workspace makes a bold statement. Foundry is ideal for creating zones and dividing open-plan workspaces.



## FEATURES

---

Recycled steel rebar used for a truly industrial finish

Available in Solid Natural Oak or Black

Available in a range of frame colors

Supplied with floor fixing as standard



## STEPS TO SPECIFY

Follow our guide and customize our products to suit your space

1 2 3

Select Product: 200 or 120 Shelves

1 2 3

Select Frame Finish: Raw finish is unavailable due to the nature of the material

RAL metal frame finishes

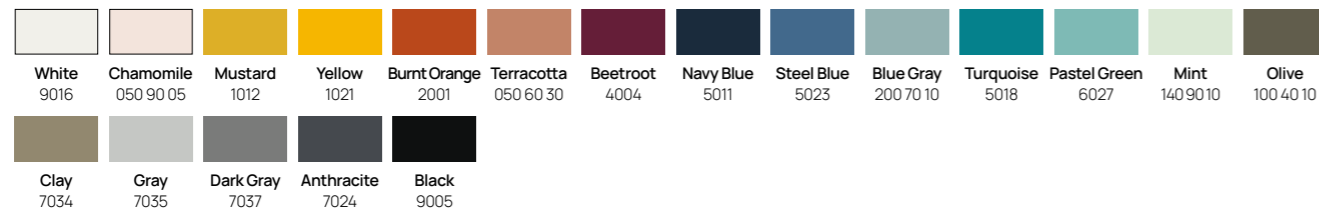

1 2 3

Select Shelf Finish: Natural or Black Oak

Wood finishes



Natural Oak Black Oak



**Foundry 200 Shelves**

width 47, depth 14, height 78.5"

DESCRIPTION	ORDER CODE	PRICE
Shelf Finish		
Natural Oak	FDU.200.NOK	\$6,433
Black Oak	FDU.200.BOK	\$6,433



**Foundry 120 Shelves**

width 47, depth 14, height 47"

DESCRIPTION	ORDER CODE	PRICE
Shelf Finish		
Natural Oak	FDU.120.NOK	\$5,583
Black Oak	FDU.120.BOK	\$5,583





# Power

DISCREET POWER  
DUET POWER

402  
403



# DISCREET POWER

Can be retrofitted on Blume, Jig Social, Slenda Table and Relic ranges  
 Discreetly placed under table tops using our integrated cable management system  
 Keeps work surfaces clear of power cut-outs, perfect for multi-use breakout spaces  
 Two options of power modules available  
 Can be positioned anywhere along the length of the table  
 Available in White

# DUET POWER

Can be added to or retrofitted on Snug, Alto, Jig, and Huddle Modular sofa ranges  
 Can be positioned on a work surface or mounted to the underframe of the sofa or table top  
 Two options of power modules available  
 Able to be retrofitted on all Booths and Sofas  
 Available in Black

**1**  
 Select Power:



2x Power Outlets



1x Power &  
1x Twin USB Charge  
(1x Type-C & 1x Type-A)

### Discreet Power

POWER TYPE	ORDER CODE			PRICE
	For Relic	For Slenda	For Jig Social	
2 x Power Outlets	DPPM.RT.A/WH	DPPM.ST.A/WH	DPPM.JS.A/WH	\$588.00
1 x Power Outlets & 1 x Twin USB	DPPM.RT.B/WH	DPPM.ST.B/WH	DPPM.JS.B/WH	\$1,044.00

Other power and data options available on request

**1**  
 Select Power:



2x Power Outlets



1x Power Outlet &  
1x Twin USB Charge  
(1x Type-C & 1x Type-A)

### Duet Power

DESCRIPTION	ORDER CODE	PRICE
<b>Under Sofa or Table Mounted</b>		
2 x Power Outlets	DUPM.SMP.A/BK	\$756.00
1 x Power Outlets & 1 x Twin USB	DUPM.SMP.B/BK	\$1,062.00
<b>Table Top Mounted</b>		
2 x Power Outlets	DUPM.TMP.A/BK	\$756.00
1 x Power Outlets & 1 x Twin USB	DUPM.TMP.B/BK	\$1,062.00



# Information

FABRIC GRADES	406
FREIGHT PROGRAM - USA	416
FREIGHT PROGRAM - CANADA	418
OTHER INFORMATION	420





## Fabric Grades & Suppliers

A selection of the product ranges from our most popular fabric manufacturers including information on suitability, sustainability, price grading and more.

The fabrics chosen here are for guidance only and other fabrics are available on request, subject to suitability.

## Fabric Suppliers

 Click the logos below to visit the suppliers website

**AGUA**  
PERFORMANCE UPHOLSTERY FABRICS



**camira**

**Gabriel**

**kvadrat**

**maharam**



**Panaz**  
Innovation in contract fabrics

**SPRADLING**

**Stinson**

 **svensson**

**MAYER  
FABRICS**

# FABRIC GRADES

## Fabrics

SUPPLIER	RANGE	COMPOSITION	FR	NOTES	PROTECTION	ECO
<b>Grade 1 (products with FBB codes)</b>						
Camira	Aspect	75% Trevira CS FR Polyester, 25% Polyester	Cigarette & Match	Seat Pad Only		
	Gravity	100% Polyester	Cigarette & Match	Seat Pad Only		
	Main Line Flax	70% Virgin wool, 30% Flax	CRIB 5			
	Main Line Plus	67% wool, 20% FR Viscose, 13% Viscose	CRIB 5			
	Quest	100% post-consumer recycled polyester including 75% SEAQUAL® YARN	Cigarette & Match	Seat Pad Only		
	Rivet	100% Repreve Recycled Polyester	Cigarette & Match	Seat Pad Only		
	X2	100% Recycled FR Polyester	CRIB 5			
Inloom	Xtreme	100% Recycled FR Polyester	CRIB 5	Seat Pad Only		
	Jet	100% Trevira CS Polyester	CRIB 5			
	Riva	100% Trevira CS Polyester	CRIB 5			
<b>Grade 2 (products with FBC codes)</b>						
Agua	Nova	100% Treated Polyester	CRIB 5	Check Application	Anti-Microbial	
Camira	24/7 Flax	50% Polyamide, 30% wool, 20% Flax	CRIB 5			
	Aquarius	100% Virgin wool	Cigarette & Match			
	Blazer	100% Virgin wool	Cigarette & Match			
	Halcyon Aspen and Blossom	100% Polyester with Trionyx backcoating	CRIB 5	Check Application	Anti-Microbial	
	Halcyon Cedar	100% Polyester with Trionyx backcoating	CRIB 5	Check Application	Anti-Microbial	
	Hemp	60% Virgin Wool, 40% True Hemp	CRIB 5	Check Application		
	Kyoto	90% Wool, 10% Polyamide	Cigarette & Match			
	Main Line Twist	75% Virgin wool, 25% Flax	Cigarette & Match	New Range		
	Oceanic	100% post-consumer recycled polyester, including 50% SEAQUAL yarn	Cigarette & Match			
	Sumi	90% Wool, 10% Polyamide	Cigarette & Match			
	Synergy	95% Virgin wool, 5% Polyamide	Cigarette & Match			
	Track	100% Trevira CS FR Polyester	CRIB 5	Check Application		
	Kvadrat	Canvas 2	90% New Wool (worsted) 10% Nylon	Cigarette & Match		
Remix 3		90% New Wool (worsted) 10% Nylon	Cigarette & Match			
Inloom	Milano	100% Trevira CS Polyester	CRIB 5			
	Jeans	100% Trevira CS	CRIB 5			
	Roccia	100% Trevira CS Polyester	CRIB 5			
Panaz	Highland Print	100% Polyester with microporous Film and FR Backcoating	CRIB 5	Seat Pad Only	Anti-Microbial	
	Kilda	100% Polyester	Cigarette & Match		Anti-Microbial	
Sunbury	Madison	100% Polyester	Cigarette & Match			
Svensson	Easy	85% Wool, 15% Polyamide	CRIB 5	Check Application		
	Semi	85% Wool, 15% Polyamide	CRIB 5	Check Application		
<b>Grade 3 (products with FBD codes)</b>						
Camira	Regent	100% Flame Retardant Polyester	Cigarette & Match			
	Silk	67% wool, 22% Flax, 11% Silk	Cigarette & Match			
Kvadrat	Atlas	90% New Wool Worsted, 10% Nylon	Cigarette & Match			
	Clara 2	92% New Wool (worsted), 8% Nylon	Cigarette & Match			
	Field 2	100% Trevira CS	CRIB 5	Seat Pad Only		
	Floyd	50% Polyester, 45% Wool (worsted), 5% Nylon	CRIB 5			
Panaz	Gridz	100% Polyester with FR Backcoating	CRIB 5	Check Application	Anti-Microbial	
	Highland Plain	100% Polyester with Microporous Film & FR Backcoating	CRIB 5		Anti-Microbial	
	Panvelle Stretch Print	Polyester/Elastane Blend with Microporous Film & FR Backcoating	CRIB 5	Check Application	Anti-Microbial	
<b>Grade 4 (products with FBE codes)</b>						
Bute	Magic	70% Wool, 25% Polyamide, 5% Other Fibres	CRIB 5			

Eco or sustainable features - please see fabric manufacturers website for further information.

## Fabrics

SUPPLIER	RANGE	COMPOSITION	FR	NOTES	PROTECTION	ECO	
Camira	Craggan Flax	100% Virgin wool	Cigarette & Match				
	Yoredale	95% Wool, 3% Polyester, 2% Polyamide	Cigarette & Match				
Svensson	Harper	100% Trevira CS	CRIB 5				
	Khaki	100% Trevira CS	CRIB 5				
	Step	100% Trevira CS	CRIB 5				
<b>Grade 5 (products with FBF codes)</b>							
Bute	Mineral	76% Wool, 21% Polyamide, 3% Other Fibres	CRIB 5				
Kvadrat	Rewool	45% New Wool (worsted), 45% Recycled Wool, 10% Nylon	Cigarette & Match				
	Tonica 2	100% New Wool	Cigarette & Match				
Svensson	Be On	92% Wool, 8% Polyamide	CRIB 5				
	Heritage Dobby	85% Wool, 15% Polyamide	Cigarette & Match				
	Poppy	100% Trevira CS	CRIB 5				
	Rami	80% Wool, 20% Ramie	CRIB 5				
<b>Grade 6 (products with FBG codes)</b>							
Bute	Melrose	93% Pure New Wool, 7% Nylon	Cigarette & Match				
Camira	Synergy Channel	95% Virgin wool, 5% Polyamide with a Polyester and Polyurethane foam backing	Cigarette & Match				
	Synergy Chevron	95% Virgin wool, 5% Polyamide with a Polyester and Polyurethane foam backing	Cigarette & Match				
	Synergy Hourglass	95% Virgin wool, 5% Polyamide with a Polyester and Polyurethane foam backing	Cigarette & Match				
Kvadrat	Divina 3	100% New Wool	CRIB 5	Check Application			
	Fiord	92% New Wool Worsted, 8% Nylon	Cigarette & Match				
	Melange Nap	97% New Wool (worsted), 3% Nylon	Cigarette & Match				
Kvadrat	Patio	100% Trevira CS	CRIB 5	Suitable Outdoors			
	Steelcut 3	90% New Wool (worsted) 10% Nylon	Cigarette & Match				
	Steelcut Trio 3	90% New Wool (worsted) 10% Nylon	Cigarette & Match				
Svensson	Accessoire	85% Wool, 15% Polyamide	Cigarette & Match	Check Application			
	Balance	82% Wool, 12% Rami, 6% Polyamide	CRIB 5				
	Debut	78% Wool, 10% Viscose, 12% Rami	CRIB 5				
	Rami Plus	80% Wool, 20% Ramie	CRIB 5				
	Velvet	100% Trevira CS	CRIB 5				
	<b>Grade 7 (products with FBH codes)</b>						
	Bute	Storr	97% Pure New Wool, 3% Nylon	CRIB 5			
Tiree		92% Pure New Wool, 8% Nylon	CRIB 5				
Kvadrat	Atrium	100% Trevira CS	CRIB 5	Suitable Outdoors			
	Divina Melange 3	100% New Wool	CRIB 5				
	Foss	76% New Wool Worsted, 11% Viscose, 8% Nylon, 5% Linen	CRIB 5				
	Hallingdal 65	70% New Wool 10% Viscose	CRIB 5				
	Maple	81% Viscose, 15% Linen, 4% Polyester	Cigarette & Match				
	Moss	52% Cotton 22% Viscose 14% Polyacrylic 6% Linen 3% Nylon 3% Polyester	Cigarette & Match	Check Application			
	Sabi	65% New Wool Worsted 23% Recycled Wool 12% Nylon	Cigarette & Match	Check Application			
	Safire	43% Viscose 17% Polyacrylic 15% New Wool 9% Cotton 8% Polyester 8% Linen	Cigarette & Match	Check Application			
	Steel Quartet	90% New Wool Worsted, 10% Nylon	Cigarette & Match	New Range			
	Svensson	Club	85% Wool, 15% Polyamide	Cigarette & Match			
	<b>Grade 8 (products with FBI codes)</b>						
Kvadrat	Balboa	100% Polyester FR	CRIB 5				
	Lila	92% New Wool Worsted, 8% Nylon	Cigarette & Match				
	Mizmaze	60% Polyester 30% New Wool 10% Nylon	Cigarette & Match				
	Safire	43% Viscose 17% Polyacrylic 15% New Wool 9% Cotton 8% Polyester 8% Linen	CRIB 5				
	Twill Weave	90% New Wool Worsted, 10% Nylon	Cigarette & Match				

Due to current supply shortages and increased leadtimes. Please check fabric stock availability with the supplier before placing order. See individual range pages for optional two-tone fabric and contrast stitching availability.

## Trost &amp; Boho Fabrics

SUPPLIER	RANGE	COMPOSITION	FR	NOTES	PROTECTION	ECO
<b>Grade 1</b> (products with FBB codes)						
Camira	Aspect	75% Trevira CS FR Polyester, 25% Polyester		Cigarette & Match		
	Main Line Flax	70% Virgin wool, 30% Flax		CRIB 5		
Inloom	Jet	100% Trevira CS Polyester		CRIB 5		
Spradling	Valencia C5	Backing - Hi-Loft 100% Cotton		CRIB 5	Boho Only	
<b>Grade 2</b> (products with FBC codes)						
Camira	Blazer	100% Virgin wool		Cigarette & Match		
	Synergy	95% Virgin wool, 5% Polyamide		Cigarette & Match		
Kvadrat	Remix 3	90% New Wool (worsted) 10% Nylon		Cigarette & Match	Boho only	
<b>Grade 4</b> (products with FBE codes)						
Camira	Craggan Flax	100% Virgin wool		CRIB 5		
	Yoredale	95% Wool, 3% Polyester, 2% Polyamide		Cigarette & Match		
<b>Grade 5</b> (products with FBF codes)						
Svensson	Rami	80% Wool, 20% Ramie		CRIB 5		
<b>Grade 6</b> (products with FBG codes)						
Kvadrat	Steelcut 3	90% New Wool (worsted) 10% Nylon		Cigarette & Match		
	Melange Nap	97% New Wool (worsted), 3% Nylon		Cigarette & Match		
<b>Grade 7</b> (products with FBH codes)						
Bute	Storr	97% Pure New Wool, 3% Nylon		CRIB 5		
	Tiree	92% Pure New Wool, 8% Nylon		CRIB 5		
<b>Grade 8</b> (products with FBI codes)						
Kvadrat	Lila	92% New Wool Worsted, 8% Nylon		Cigarette & Match		
	Twill Weave	90% New Wool Worsted 10% Nylon		Cigarette & Match	Boho only	

## Outdoor Fabrics

SUPPLIER	RANGE	COMPOSITION	FR	NOTES	PROTECTION	ECO
<b>Grade 6</b> (products with FBF codes)						
Kvadrat	Patio	100% Trevira CS		CRIB 5		
<b>Grade 7</b> (products with FBG codes)						
Kvadrat	Atrium	100% Trevira CS		CRIB 5		

## Vinyls

SUPPLIER	RANGE	COMPOSITION	FR	NOTES	PROTECTION	ECO
<b>Grade 1</b>						
Spradling	Valencia C5	Backing - Hi-Loft 100% Cotton		CRIB 5		Anti-Bacterial
<b>Grade 2</b> (products with FBI codes)						
Camira	Vita	Surface 98.5% PVC, 1.5% PU, Substrate 50% Polyester, 50% Cotton		Cigarette & Match		Anti-Microbial
Panaz	Brookland	Coating: PVC/PU/Acryltron, Basedcloth: Cotton/Polyester		CAL TB 117		Anti-Microbial
	Vintage	Coating: PVC/PU/Acryltron, Basedcloth: Cotton/Polyester		CAL TB 117		
<b>Grade 3</b>						
Mayer	Silverweave			CAL TB 117		
Spradling	Avantgarde	Backing - 100% Cotton		CRIB 7		Anti-Bacterial
	Chronos	Backing - 100% Cotton		CRIB 5		Anti-Bacterial
	Silvertex C5	Backing - Hi-Loft 100% Cotton		CRIB 5		Anti-Bacterial
<b>Grade 4</b>						
Mayer	Galverston	80% Vinyl - Phthalate Free face, 20% Polyester backing		CAL TB 117		
Momentum	Canter Epu	High Performance 100% EPU Polyurethane		CAL TB 117	Seat Pad only	
	Endurance Epu	High Performance 100% EPU Polyurethane		CAL TB 117		
	Tribeca CV Epu	High Performance 100% EPU Polyurethane		CAL TB 117		
	Vanguard CV Epu	High Performance 100% EPU Polyurethane		CAL TB 117		
Spradling	Dolce	100% Polyurethane		CRIB 5		Anti-Bacterial
Stinson	Avant	Vinyl Surface with Polyester / Cotton Backing		CAL TB 117		
<b>Grade 5</b>						
Momentum	Cashmere II	100% Polyurethane / PVC Free		CAL TB 117		
	Row	100% Polyurethane / PVC Free		CAL TB 117		
<b>Grade 6</b>						
Maharam	Lariat	100% Non-Phthalate Vinyl		CAL TB 117		
Momentum	Silica	100% Silicone		CAL TB 117		Anti-Bacterial
<b>Grade 8</b>						
Camira	Deca	100% PU, Substrate: 100% Cotton		Cigarette & Match		

## Leather

SUPPLIER	RANGE	COMPOSITION	FR	NOTES	PROTECTION	ECO
<b>Grade 1</b>						
Crest	Shelly					
<b>Grade 2</b>						
Muirhead	Caledonian					
	Grampian					
Yarwood	Chelsea					
<b>Grade 3</b>						
Neuman	Old Colonial					

PLEASE NOTE: Leather is a natural material and will crease and 'puddle' with use.

Due to current supply shortages and increased leadtimes. Please check fabric stock availability with the supplier before placing order. See individual range pages for optional two-tone fabric and contrast stitching availability.  
**Note:** Not all the fabrics listed above are suitable for all Frövi products. Please ensure when selecting a fabric that it is suitable for the specific furniture item. Frövi reserves the right to decline to use any fabric which it deems unsuitable for a particular furniture product. Many fabrics are tested to BS 7176:2007 Medium Hazard (Crib 5) but this is not universal. **If in doubt please contact Frövi sales office for confirmation. Call +44 (0) 1608 652411.**

# QUICKSHIP FABRIC GRADES

## Fabrics

SUPPLIER	RANGE	COMPOSITION	FR	NOTES	PROTECTION	ECO	
<b>Grade 1 (products with FBB codes)</b>							
Camira	Aspect	75% Trevira CS FR Polyester, 25% Polyester	Cigarette & Match	Seat Pad Only			
	Gravity	100% Polyester	Cigarette & Match	Seat Pad Only			
	Main Line Flax	70% Virgin wool, 30% Flax	CRIB 5				
	Main Line Plus	67% wool, 20% FR Viscose, 13% Viscose	CRIB 5				
	Quest	100% post-consumer recycled polyester including 75% SEAQUAL® YARN	Cigarette & Match	Seat Pad Only			
	Rivet	100% Repreve Recycled Polyester	Cigarette & Match	Seat Pad Only			
	X2	100% Recycled FR Polyester	CRIB 5				
	Xtreme	100% Recycled FR Polyester	CRIB 5	Seat Pad Only			
<b>Grade 2 (products with FBC codes)</b>							
Camira	24/7 Flax	50% Polyamide, 30% wool, 20% Flax	CRIB 5				
	Aquarius	100% Virgin wool	Cigarette & Match				
	Blazer	100% Virgin wool	Cigarette & Match				
	Halcyon Aspen and Blossom	100% Polyester with Trionyx backcoating	CRIB 5	Check Application	Anti-Microbial		
	Halcyon Cedar	100% Polyester with Trionyx backcoating	CRIB 5	Check Application	Anti-Microbial		
	Hemp	60% Virgin Wool, 40% True Hemp	CRIB 5	Check Application			
	Kyoto	90% Wool, 10% Polyamide	Cigarette & Match				
	Main Line Twist	75% Virgin wool, 25% Flax	Cigarette & Match	New Range			
	Oceanic	100% post-consumer recycled polyester, including 50% SEAQUAL yarn	Cigarette & Match				
	Sumi	90% Wool, 10% Polyamide	Cigarette & Match				
	Synergy	95% Virgin wool, 5% Polyamide	Cigarette & Match				
	Track	100% Trevira CS FR Polyester	CRIB 5	Check Application			
	Kvadrat	Remix 3	90% New Wool (worsted), 10% Nylon	Cigarette & Match			
	Mayer	Bali	98% Olefin, 2% Polyester	CAL TB 117			
	Panaz	Highland Print	100% Polyester with microporous Film and FR Backcoating	CRIB 5	Seat Pad Only	Anti-Microbial	
		Kilda	100% Polyester	Cigarette & Match		Anti-Microbial	
		Piccadilly	100% Polyester				
Stinson	Fleck	100% Polyester	CAL TB 117				
	Hive	100% Polyester	CAL TB 117				
	Sprint	100% Polyester	CAL TB 117				
	Tribeca	100% Polyester	CAL TB 117				
Svensson	Easy	85% Wool, 15% Polyamide	CRIB 5	Check Application			
	Semi	85% Wool, 15% Polyamide	CRIB 5	Check Application			
<b>Grade 3 (products with FBD codes)</b>							
Camira	Regent	100% Flame Retardant Polyester	Cigarette & Match				
	Silk	67% wool, 22% Flax, 11% Silk	Cigarette & Match				
Kvadrat	Atlas	90% New Wool Worsted, 10% Nylon	Cigarette & Match				
	Canvas 2	90% New Wool (worsted), 10% Nylon	CAL TB 117				
	Clara 2	92% New Wool (worsted), 8% Nylon	Cigarette & Match				
	Field 2	100% Trevira CS	CRIB 5	Seat Pad Only			
	Floyd	50% Polyester, 45% Wool (worsted), 5% Nylon	CRIB 5				
Maharam	Merit	76% Post consumed Recycled Polyester, 24% Polyester	Cigarette & Match				
Momentum	Cover Cloth	56% Post Consumer Recycled Polyester, 44% Polyester		Check Application			
	Flux	70% Cotton, 26% Nylon, 4% Rayon	CAL TB 117				
Panaz	Oath	50% Post Consumer Recycled Polyester, 50% Polyester	CAL TB 117				
	Gridz	100% Polyester with FR Backcoating	CRIB 5	Check Application	Anti-Microbial		

Eco or sustainable features - please see fabric manufacturers website for further information.

## Fabrics

SUPPLIER	RANGE	COMPOSITION	FR	NOTES	PROTECTION	ECO
	Highland Plain	100% Polyester with Microporous Film & FR Backcoating	CRIB 5		Anti-Microbial	
	Panvelle Stretch Print	Polyester/Elastane Blend with Microporous Film & FR Backcoating	CRIB 5	Check Application	Anti-Microbial	
	Regal	100% Polyester	CAL TB 117			
Stinson	Artisan	100% Polyester	CAL TB 117			
<b>Grade 4 (products with FBE codes)</b>						
Camira	Craggan Flax	100% Virgin wool	Cigarette & Match			
	Yoredale	95% Wool, 3% Polyester, 2% Polyamide	Cigarette & Match			
Kvadrat	Clara 2	92% New Wool (worsted), 8% Nylon	CAL TB 117			
Maharam	Metric	51% Post industrial recycled, 49% Polyester	Cigarette & Match			
Mayer	Abbey	100% Polyester				
Momentum	Ace	100% Post Consumer Recycled Polyester	CAL TB 117			
	Decode	100% Post Consumer Recycled Polyester	CAL TB 117			
	Epic	Recycled Polyester, 18% Post Consumer Recycled Polyester	CAL TB 117			
	Faux Felt	62% Post Consumer Recycled Polyester, 38% Polyester	CAL TB 117			
	Fold	75% Cotton, 25% Nylon	CAL TB 117			
	Hue	Polyester, 35% Post Consumer Recycled Polyester	CAL TB 117			
	Odyssey C-Zero	67% Post Consumer Recycled Polyester, 33% Polyester	CAL TB 117			
Stinson	Tradition C-Zero	72% Post Consumer Recycled Polyester, 28% Polyester	CAL TB 117			
	Artisan	100% Polyester				
	Criss Cross	Non-Phthalate Vinyl Surface with Polyester Backing	CAL TB 117			
Svensson	Tribeca	100% Polyester with SBR Synthetic Back Coating				
	Harper	100% Trevira CS	CRIB 5			
	Khaki	100% Trevira CS	CRIB 5			
	Step	100% Trevira CS	CRIB 5			
<b>Grade 5 (products with FBF codes)</b>						
Designtex	Brushed Flannel	100% Polyester	CAL TB 117			
	Cloud Velvet	100% Polyester	CAL TB 117			
Kvadrat	Rewool	45% New Wool (worsted), 45% Recycled Wool, 10% Nylon	Cigarette & Match			
	Tonica 2	100% New Wool	Cigarette & Match			
Momentum	Graph	75% Post Consumer Recycled Polyester, 25% Polyester	CAL TB 117			
	Hyde	100% Clean Vinyl/Phthalate Free	CAL TB 117			
	Origin	100% Post Consumer Recycled Polyester	CAL TB 117			
Stinson	Trivia	100% Repreve® Solution Dyed Recycled Nylon	CAL TB 117			
	Adagio	100% Polyester	CAL TB 117			
	Montage	100% Polyester	CAL TB 117			
Svensson	Be On	92% Wool, 8% Polyamide	CRIB 5			
	Heritage Dobby	85% Wool, 15% Polyamide	Cigarette & Match			
	Poppy	100% Trevira CS	CRIB 5			
	Rami	80% Wool, 20% Ramie	CRIB 5			
<b>Grade 6 (products with FBG codes)</b>						
Camira	Synergy Channel	95% Virgin wool, 5% Polyamide with a Polyester and Polyurethane foam backing	Cigarette & Match			
	Synergy Chevron	95% Virgin wool, 5% Polyamide with a Polyester and Polyurethane foam backing	Cigarette & Match			
	Synergy Hourglass	95% Virgin wool, 5% Polyamide with a Polyester and Polyurethane foam backing	Cigarette & Match			
Designtex	Billard Cloth	100% Polyester				
	Fomo	25% Acrylic, 25% Cotton, 41% Polyester, 9% Rayon	CAL TB 117			
	Melange	100% Polyester	CAL TB 117			

Due to current supply shortages and increased leadtimes, please check fabric stock availability with the supplier before placing order. See individual range pages for optional two-tone fabric and contrast stitching availability.

## Fabrics

SUPPLIER	RANGE	COMPOSITION	FR	NOTES	PROTECTION	ECO	
<b>Kvadrat</b>	Divina 3	100% New Wool	CRIB 5	Check Application			
	Divina MD	100% New Wool Sustainable	CAL TB 117				
	Fiord	92% New Wool Worsted, 8% Nylon	Cigarette & Match				
	Melange Nap	97% New Wool (worsted), 3% Nylon	Cigarette & Match				
	Patio	100% Trevira CS	CRIB 5	Suitable Outdoors			
<b>Kvadrat</b>	Steelcut 3	90% New Wool (worsted) 10% Nylon	Cigarette & Match				
	Steelcut Trio 3	90% New Wool (worsted) 10% Nylon	Cigarette & Match				
<b>Maraham</b>	Mantel	59% Post Consumed Recycled Polyester, 37% Polyester, 4% Spandex	Cigarette & Match				
<b>Momentum</b>	Build	Polyester, 35% Polyester, 10% Post Consumer Recycled Polyester	CAL TB 117				
	Channel	74% Post Consumer Recycled Polyester, 26% Polyester	CAL TB 117				
	Cover Cloth	56% Post Consumer Recycled Polyester, 44% Polyester	CAL TB 117				
	Faux MO	58% Post Consumer Recycled Polyester, 42% Polyester	CAL TB 117				
	Flock	53% Recycled Polyester, 47% Polyester	CAL TB 117				
	Keeper	100% Clean Vinyl/Phthalate Free	CAL TB 117				
	Kit	57% Recycled Polyester, 43% Polyester	CAL TB 117				
	Mantra	100% Polyester	CAL TB 117				
	Shuttle	89% Recycled Polyester, 11% Polyester	CAL TB 117				
	Sunny	39% Polyester, 38% Post Consumer Recycled Polyester, 23% Post Industrial Recycled Polyester	CAL TB 117				
	Rein	100% Polyurethane / PVC Free	CAL TB 117				
	<b>Panaz</b>	Harvard	Polyester with FR backcoating	IMO FTP			
	<b>Stinson</b>	Ritz	100% Polyester with Crypton® Integrated Fluid Barrier				
<b>Svensson</b>	Accessoire	85% Wool, 15% Polyamide	Cigarette & Match	Check Application			
	Balance	82% Wool, 12% Rami, 6% Polyamide	CRIB 5				
	Debut	78% Wool, 10% Viscose, 12% Rami	CRIB 5				
	Rami Plus	80% Wool, 20% Ramie	CRIB 5				
	Velvet	100% Trevira CS	CRIB 5				
<b>Grade 7 (products with FBH codes)</b>							
<b>Designtex</b>	Hint	50% Acrylic, 50% Polyester	CAL TB 117				
<b>Kvadrat</b>	Atrium	100% Trevira CS	CRIB 5	Suitable Outdoors			
	Divina Melange 3	100% New Wool	CRIB 5				
	Foss	76% New Wool Worsted, 11% Viscose, 8% Nylon, 5% Linen	CRIB 5				
	Hallingdal 65	70% New Wool 10% Viscose	CRIB 5				
	Maple	81% Viscose, 15% Linen, 4% Polyester	Cigarette & Match				
	Moss	52% Cotton 22% Viscose 14% Polyacrylic 6% Linen 3% Nylon 3% Polyester	Cigarette & Match	Check Application			
	Sabi	65% New Wool Worsted 23% Recycled Wool 12% Nylon	Cigarette & Match	Check Application			
	Safire	43% Viscose 17% Polyacrylic 15% New Wool 9% Cotton 8% Polyester 8% Linen	Cigarette & Match	Check Application			
	Steel Quartet	90% New Wool Worsted, 10% Nylon	Cigarette & Match	New Range			
	<b>Momentum</b>	Leafdot	100% Clean Vinyl/ Phthalate Free	CAL TB 117			
Pip		53% Recycled Polyester, 47% Polyester	CAL TB 117				
<b>Panaz</b>	Brookland	PVC/PU Blend, Basecloth: Polyester/Viscose Vinyl Seating	CAL TB 117				
	Vintage		CAL TB 117				
<b>Svensson</b>	Club	85% Wool, 15% Polyamide	Cigarette & Match				
<b>Grade 8 (products with FBI codes)</b>							
<b>Kvadrat</b>	Balboa	100% Polyester FR	CRIB 5				
	Lila	92% New Wool Worsted, 8% Nylon	Cigarette & Match				
	Mizmaze	60% Polyester 30% New Wool 10% Nylon	Cigarette & Match				
	Safire	43% Viscose 17% Polyacrylic 15% New Wool 9% Cotton 8% Polyester 8% Linen	CRIB 5				
	Twill Weave	90% New Wool Worsted, 10% Nylon	Cigarette & Match				
<b>Maharam</b>	Compound	100% Polyurethane	CAL TB 117				
	Gemma	85% Wool, 15% Nylon	CAL TB 117				
<b>Momentum</b>	Bravo II	100% Polyurethane / PVC Free	CAL TB 117				
	Fuse	Polyester, 35% Post Consumer Recycled Polyester	CAL TB 117				
	Tradewinds	100% Clean Vinyl/ Phthalate Free	CAL TB 117				

## Vinyls

SUPPLIER	RANGE	COMPOSITION	FR	NOTES	PROTECTION	ECO
<b>Grade 1</b>						
<b>Spradling</b>	Valencia C5	Backing - Hi-Loft 100% Cotton	CRIB 5		Anti-Bacterial	
<b>Grade 2</b>						
<b>Camira</b>	Vita	Surface 98.5% PVC, 1.5% PU, Substrate 50% Polyester, 50% Cotton	Cigarette & Match		Anti-Microbial	
<b>Panaz</b>	Brookland	Coating: PVC/PU/Acryltron, Basecloth: Cotton/Polyester	CAL TB 117		Anti-Microbial	
	Vintage	Coating: PVC/PU/Acryltron, Basecloth: Cotton/Polyester	CAL TB 117			
<b>Grade 3</b>						
<b>Mayer</b>	Silverweave		CAL TB 117			
<b>Spradling</b>	Avantgarde	Backing - 100% Cotton	CRIB 7		Anti-Bacterial	
	Chronos	Backing - 100% Cotton	CRIB 5		Anti-Bacterial	
	Silververtex C5	Backing - Hi-Loft 100% Cotton	CRIB 5		Anti-Bacterial	
<b>Grade 4</b>						
<b>Mayer</b>	Galverston	80% Vinyl - Phthalate Free face, 20% Polyester backing	CAL TB 117			
<b>Momentum</b>	Canter Epu	High Performance 100% EPU Polyurethane	CAL TB 117	Seat Pad only		
	Endurance Epu	High Performance 100% EPU Polyurethane	CAL TB 117			
	Tribeca CV Epu	High Performance 100% EPU Polyurethane	CAL TB 117			
	Vanguard CV Epu	High Performance 100% EPU Polyurethane	CAL TB 117			
<b>Spradling</b>	Dolce	100% Polyurethane	CRIB 5		Anti-Bacterial	
<b>Stinson</b>	Avant	Vinyl Surface with Polyester / Cotton Backing	CAL TB 117			
<b>Grade 5</b>						
<b>Momentum</b>	Cashmere II	100% Polyurethane / PVC Free	CAL TB 117			
	Row	100% Polyurethane / PVC Free	CAL TB 117			
<b>Grade 6</b>						
<b>Maharam</b>	Lariat	100% Non-Phthalate Vinyl	CAL TB 117			
<b>Momentum</b>	Silica	100% Silicone	CAL TB 117		Anti-Bacterial	
<b>Grade 8</b>						
<b>Camira</b>	Deca	100% PU, Substrate: 100% Cotton	Cigarette & Match			

Due to current supply shortages and increased leadtimes, please check fabric stock availability with the supplier before placing order. See individual range pages for optional two-tone fabric and contrast stitching availability.

**Note:** Not all the fabrics listed above are suitable for all Frövi products. Please ensure when selecting a fabric that it is suitable for the specific furniture item. Frövi reserves the right to decline to use any fabric which it deems unsuitable for a particular furniture product. Many fabrics are tested to BS 7176:2007 Medium Hazard (Crib 5) but this is not universal. **If in doubt please contact Frövi sales office for confirmation. Call +44 (0) 1608 652411.**



# FREIGHT PROGRAM: USA

## Key

<b>Zone 1</b>	2% of list or \$200 minimum	
<b>Zone 2</b>	3% of list or \$250 minimum	
<b>Zone 3</b>	4% of list or \$300 minimum	
<b>Zone 4</b>	5% of list or \$350 minimum	See chart

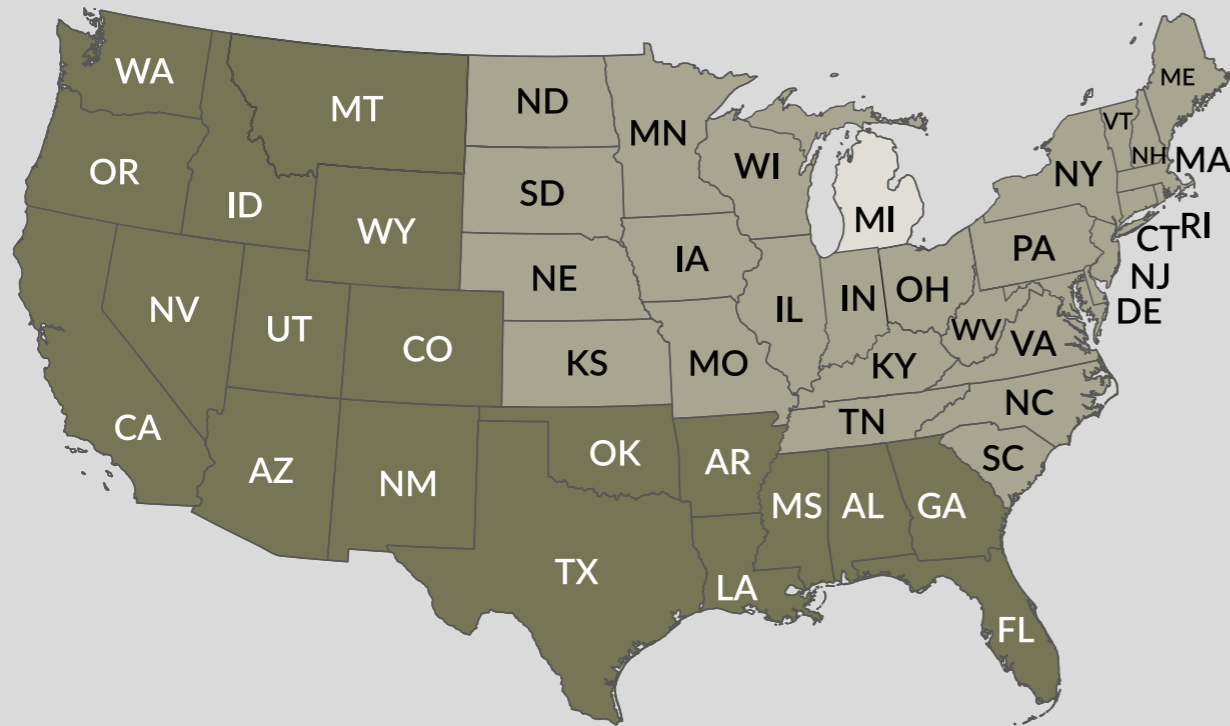

## Frövi Freight Program: United States

<b>Alabama</b>	Zone 3	<b>Montana</b>	Zone 3
<b>Alaska</b>	Zone 4	<b>Nebraska</b>	Zone 2
<b>Arizona</b>	Zone 3	<b>Nevada</b>	Zone 3
<b>Arkansas</b>	Zone 3	<b>New Hampshire</b>	Zone 2
<b>California</b>	Zone 3	<b>New Jersey</b>	Zone 2
<b>Colorado</b>	Zone 3	<b>New Mexico</b>	Zone 3
<b>Connecticut</b>	Zone 2	<b>New York</b>	Zone 2
<b>Delaware</b>	Zone 2	<b>North Carolina</b>	Zone 2
<b>District of Columbia</b>	Zone 2	<b>North Dakota</b>	Zone 2
<b>Florida</b>	Zone 3	<b>Ohio</b>	Zone 2
<b>Georgia</b>	Zone 3	<b>Oklahoma</b>	Zone 3
<b>Hawaii</b>	Zone 4	<b>Oregon</b>	Zone 3
<b>Idaho</b>	Zone 3	<b>Pennsylvania</b>	Zone 2
<b>Illinois</b>	Zone 2	<b>Rhode Island</b>	Zone 2
<b>Indiana</b>	Zone 2	<b>South Carolina</b>	Zone 2
<b>Iowa</b>	Zone 2	<b>South Dakota</b>	Zone 2
<b>Kansas</b>	Zone 2	<b>Tennessee</b>	Zone 2
<b>Kentucky</b>	Zone 2	<b>Texas</b>	Zone 3
<b>Louisiana</b>	Zone 3	<b>Utah</b>	Zone 3
<b>Maine</b>	Zone 2	<b>Vermont</b>	Zone 2
<b>Maryland</b>	Zone 2	<b>Virginia</b>	Zone 2
<b>Massachusetts</b>	Zone 2	<b>Washington</b>	Zone 3
<b>Michigan</b>	Zone 1	<b>West Virginia</b>	Zone 2
<b>Minnesota</b>	Zone 2	<b>Wisconsin</b>	Zone 2
<b>Mississippi</b>	Zone 3	<b>Wyoming</b>	Zone 3
<b>Missouri</b>	Zone 2		

Some exceptions may apply

- This policy applies to single shipments to 1 US/CDN location
- A surcharge may apply to shipments where delivery is requested for a specific day/time
- Blanket wrap option is available upon request. Additional charges apply, please call for pricing

# FREIGHT PROGRAM: CANADA

## Key

<b>Zone 1</b>	2% of list or \$200 minimum	
<b>Zone 2</b>	3% of list or \$250 minimum	
<b>Zone 3</b>	4% of list or \$300 minimum	
<b>Zone 4</b>	5% of list or \$350 minimum	



## Frövi Freight Program: Canada

<b>Alberta</b>	Zone 3
<b>British Columbia</b>	Zone 4
<b>Manitoba</b>	Zone 2
<b>New Brunswick</b>	Zone 3
<b>Newfoundland and Labrador</b>	Zone 4
<b>Northwest Territories</b>	Zone 4
<b>Nova Scotia</b>	Zone 3
<b>Nunavut</b>	Zone 4
<b>Ontario - North</b>	Zone 2
<b>Ontario - South</b>	Zone 1
<b>Prince Edward Island</b>	Zone 3
<b>Quebec</b>	Zone 2
<b>Saskatchewan</b>	Zone 3
<b>Yukon Territory</b>	Zone 4

Some exceptions may apply

- This policy applies to single shipments to 1 US/CDN location
- A surcharge may apply to shipments where delivery is requested for a specific day/time
- Blanket wrap option is available upon request. Additional charges apply, please call for pricing

# INFORMATION

**Our passion for quality is infused into each piece of Frövi furniture.**

## IMPACT ON THE ENVIRONMENT

We believe that environmental and ethical values should lie at the core of our vision for the future. Protecting the environment is paramount for both us and future generations. Every product we produce has an environmental impact but at Frövi we are constantly striving to reduce the impact of this as far as possible. To attain these goals, we constantly review best practice to ensure your Frövi product is produced to the highest standard of sustainability. These goals include resource and waste management to reduce our carbon footprint through reduction of energy consumption, recycling and minimizing our waste to landfill.

### ISO

Frövi is a registered ISO 9001:2015 and ISO 14001:2015 company.



## QUALITY, STANDARDS AND TESTING

Quality is vital in all Frövi products. Frövi is committed to ever increasing product quality. Regular quality control checks coupled with ongoing rigorous research and development keeps Frövi at the forefront of the industry. Many Frövi products are tested to international standard (ISO, BSEN) at recognised test facilities, such as FIRA, SATRA and CATAS, thus giving our customers peace of mind that the product they are purchasing has been rigorously tested in laboratory conditions to ensure its safety and suitability for use in the contract environment.

Certificates, where relevant, are available on request.



## 10 YEAR LIMITED WARRANTY

All Frövi products carry a 10 Year Limited structural warranty in North America. Any defects in material specified by the customer such as fabrics, laminates and veneers which are not manufactured by Frövi, will be subject to the original manufacturer's warranty terms & conditions. All other exceptions and exclusions can be found in the full version of the warranty.

Any damage caused by accident, misuse, abuse, neglect and standard wear & tear, is not covered by this warranty. Frövi reserves the right to decide whether to repair and/or replace any product/s that are deemed to be covered by their warranty and the decision by Frövi is final.

Full detailed copies of both the Frövi 10 Year Limited Warranty and Frövi Terms & Conditions of Sale are available on request from [sales@frovidesign.com](mailto:sales@frovidesign.com).

## DESIGN REGISTRATION

All Frövi-designed products are registered with the Intellectual Property Office. This Government registration is in place to prevent the copying or stealing of our designs. The design registration covers the look of Frövi designs including the appearance, physical shape, configuration (or how different parts of a design are arranged together) and decoration.

By registering our designs, Frövi is protected against anyone copying them and we have the right to prevent others using our designs for up to 25 years. Frövi can take legal action against any design infringement and/or design copying.

Further details and registration number are available on request.

## POWDER COATING

Frövi powder coating has had a full LCA (Life Cycle Analysis) conducted upon it. The reason for conducting this analysis is to provide a transparent, accurate and third party accredited breakdown of the environmental impact of the product.

The reason we've adopted this strategy is part of our commitment to ensure our products have sustainability designed into them from the ground up. Our process provides many sustainability benefits compared to other powder coating methods, including reduced energy usage and reduced waste generation.

Our specially designed powder coatings can be cured at lower oven temperatures making them suitable for a variety of substrates. This leads to reduced energy usage and a lower carbon footprint. It is a hard-wearing coating for exterior architecture and furniture. This cures in 12 minutes at 170 degrees.

Frövi powder coating meets the tough weathering requirements of leading industry specifications such as; Qualicoat class 2, GSB Master, AAMA2604, BS EN 12206, and matches the mechanical performance advantages (flexibility) of Qualicoat class 1 standard durable systems.

## SCS INDOOR ADVANTAGE GOLD



All Frövi products are certified SCS Indoor Advantage Gold meaning that we meet the most stringent and internationally accepted standards for Indoor Air Quality. This ensures that no harmful pollutants are released into the air when using our products and further demonstrates our commitment to an environment that is safe, healthy, and sustainable. All relevant product testing certificates are available upon request.

## WOOD SEATING & TABLES

Frövi cannot guarantee an exact match of any wood items, and any variation in color, texture or grain is not considered a defect due to the natural properties of the material. Matching of colors between different batches is also not guaranteed, as wood finishes will age with time and exposure to sunlight. Wooden furniture is exclusively designed for indoor use and should not be exposed to increased humidity.

## MY RESOURCE LIBRARY

My Resource Library (MRL) is the industry's go-to virtual library. It offers easy online access to resources once found in a physical library as well as rich project ideation, collaboration, and visualization tools. Check out our Frövi binder on MRL for up-to-date literature, images, rep locator, and more. [myresourcelibrary.com](http://myresourcelibrary.com)

© July 2023. Edition 3. Frövi North America

No part of this publication may be reproduced in any material form (including photocopying or storing it in any medium by electronic means and whether or not transiently, or incidentally to some other use of this publication) without the written permission of the copyright owner. Application for the copyright owner's permission to reproduce any part of this publication should be addressed to Frövi.

Where color and finish samples are shown within this document limitations in the reprographics process mean absolute color accuracy cannot be guaranteed. Where color matching is critical, a sample of the material can be provided on request.

**Frövi reserves the right to alter specification and designs without prior notice. E&OE.**

**Call** +1 (833) 873-4336

**Email** [info@frovidesign.com](mailto:info@frovidesign.com)

**Visit** [frovidesign.com](http://frovidesign.com)

© October 2023. Frövi North America. Edition 2. All rights reserved.

**FRÖVI**<sup>®</sup>

---

**North America**  
45 Goodrich Dr,  
B2 Kitchener,  
Ontario  
Canada  
N2C 0B8

**Chicago Showroom**  
The Mart  
Floor 11, Suite 101,  
222 Merchandise  
Mart Plaza  
Chicago, IL 60654

**US Warehouse**  
9420  
Knight Road  
Houston,  
TX 77045,  
USA

**UK Head Office**  
Cotswold Business  
Village, London Road,  
Moreton in Marsh  
Gloucestershire  
GL56 OPS

**London  
Showroom**  
5 Sycamore Street  
Clerkenwell  
London  
EC1Y 0SG

**Design Hub**  
Unit E, Park 34  
Collect Way,  
Didcot  
Oxfordshire  
OX11 7WB